

ANYONE[®] Onestage

by MEGA'GEN





ANYONE[®] Onestage

by MEGA'GEN

Key Advantages

The convenience of a single prosthetic connection for all fixture size.

Compatibility of connection with many other implant system
(8° Internal 3.1 Octa Connection).

004 Characteristics & Advantages

004 I. Features

006 II. Variety of AnyOne[®] OneStage Fixtures

007 Fixture Product

007 I. Fixture Dimension

008 II. Fixture Size

010 Closing Screw & Cover Screw & Healing Abutment

011 Abutment & Prosthetic Options

011 I. Abutment Level Prosthesis

011 1. Solid Abutment & Components

015 2. Octa Abutment & Components

018 II. Fixture Level Prosthesis

022 III. Overdenture Prosthesis

022 1. Meg-Loc Abutment & Component

024 2. Meg-Ball Abutment & Component

026 3. Meg-Magnet Abutment & Component

028 AnyOne Surgical Kit

028 I. AnyOne OneStage Kit

037 II. Stopper Drill Kit

038 III. Prosthetic Kit

040 IV. Bone Profiler Kit

041 V. Optional components

046 Digital Material

046 I. ZrGEN

046 II. TiGEN

Characteristics & Advantages

I. Features

1. Optimum Transgingival Cuff Part enables successful 1 Stage Surgery with quick restoration and precise joining of peripheral gingiva

- The anodizing part is located below the Tissue to provide an aesthetic design

2. Simplified surgical protocol with predictable initial stability

- Advanced fixture design allows easier drilling in any bone density while ensuring initial stability.
- Wide range of choices : Ø3.5/ 4.0/ 4.5/ 5.0/ 6.0 size.
- Compatibility with ExFeel External prosthesis.

• From the smallest to the largest

Wide selection of fixture size of diameters and lengths from Ø3.5 ~ to Ø6.0, from 7mm to 15mm length adjust to all the bone condition.



3. Stress distribution on cancellous bone

- Attain the best ISQ value with MegaGen's original Knife Thread® design.
- Thanks to its unique knife thread super self- tapping design, better initial stability can be attained in any compromised bone situation. It offers progressive bone condensing, ridge expansion, maximized compressive force resistance and minimized shear force production.

KnifeThread®

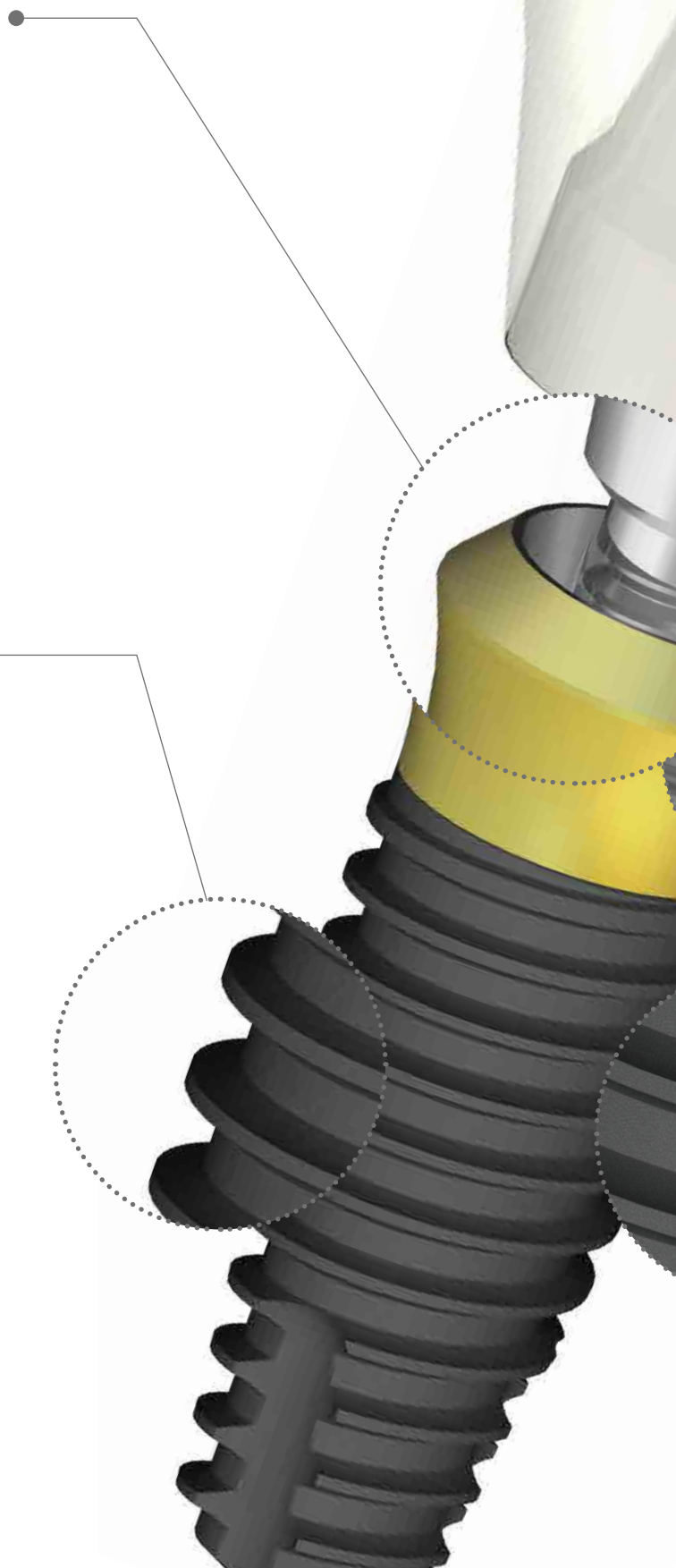
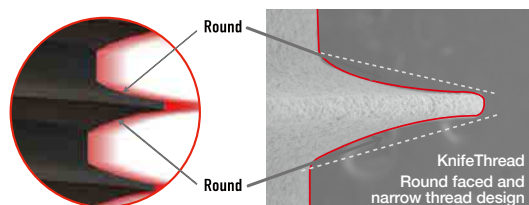

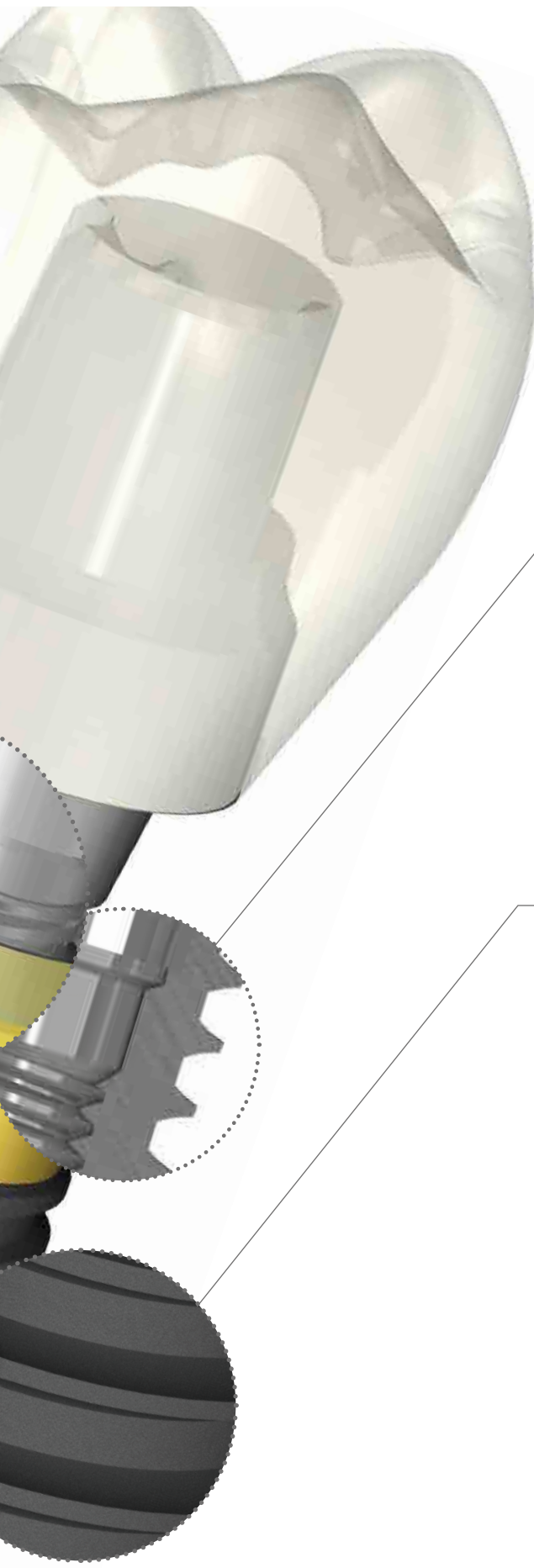

● **4. The convenience of a octa prosthetic connection for all fixture sizes with an 8 degree internal hex connection**

- Available to all cases
- Compatible with ExFeel Internal Prosthesis products
- Compatible with Classical small or regular size of ITI type abutments

● **5. World's renowned S-L-A Surface Treatment**

- Ideal Macro & Micro roughness was created through safety-proven blasting and etching processes which result in excellent bone formation and morphology
(It can be a discomfort object when placing the fixture, if surface is too sharp)

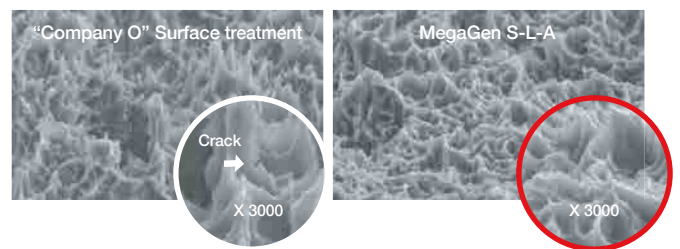

II. Variety of AnyOne[®] OneStage Fixtures

AnyOne has variety of choice.

1. Easy and convenient “Regular Thread”



For Hard Bone

Easy and Simple placement for all cases.

Ø3.5, Ø4.0, Ø4.5, Ø5.0

2. “Deep Thread” for stronger initial fixation



For Soft Bone

New design with extended thread gives substantially stronger initial stability for soft bone application.

Ø4.5, Ø5.0



Deep Thread

Fixture Product

I. Fixture Dimension

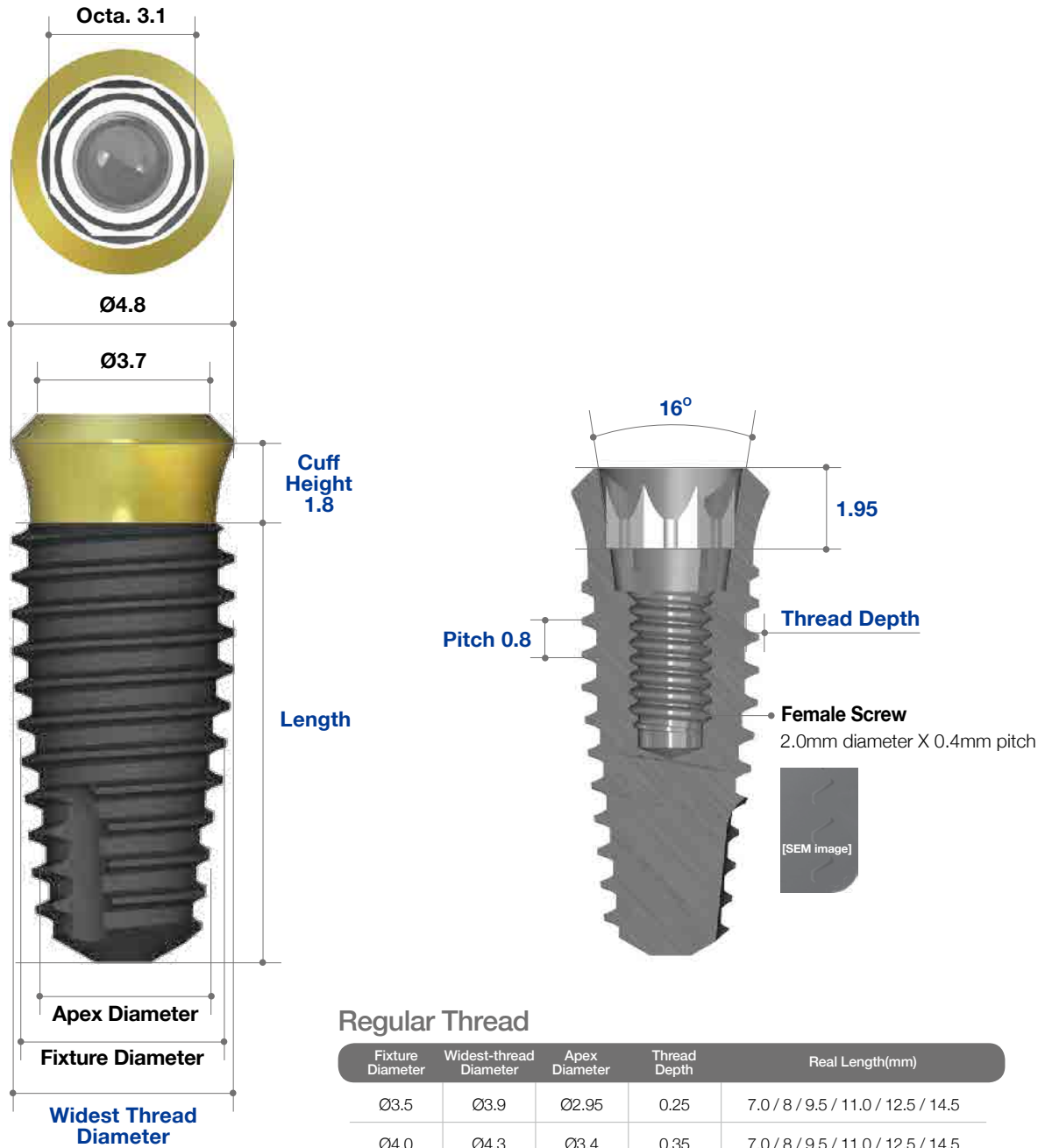

Regular Thread

Fixture Diameter	Widest-thread Diameter	Apex Diameter	Thread Depth	Real Length(mm)
Ø3.5	Ø3.9	Ø2.95	0.25	7.0 / 8 / 9.5 / 11.0 / 12.5 / 14.5
Ø4.0	Ø4.3	Ø3.4	0.35	7.0 / 8 / 9.5 / 11.0 / 12.5 / 14.5
Ø4.5	Ø4.8	Ø3.9	0.35	7.0 / 8 / 9.5 / 11.0 / 12.5 / 14.5
Ø5.0	Ø5.3	Ø4.4	0.35	7.0 / 8 / 9.5 / 11.0 / 12.5 / 14.5

Deep Thread

Fixture Diameter	Widest-thread Diameter	Apex Diameter	Thread Depth	Real Length(mm)
Ø4.5	Ø4.8	Ø3.9	0.6	7.0 / 8 / 9.5 / 11.0 / 12.5 / 14.5
Ø5.0	Ø5.3	Ø4.4	0.85	7.0 / 8 / 9.5 / 11.0 / 12.5 / 14.5

II. Fixture Size

Regular Thread Ø3.5

- Healing Abutment(IRH503) included

Diameter(mm)	Length(mm)	Ref.C
Ø3.5	7.0	OSF3507H
	8.5	OSF3508H
	10.0	OSF3510H
	11.5	OSF3511H
	13.0	OSF3513H
	15.0	OSF3515H

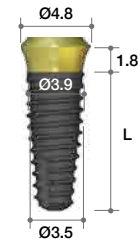

Regular Thread Ø4.0

- Healing Abutment(IRH503) included

Diameter(mm)	Length(mm)	Ref.C
Ø4.0	7.0	OSF4007H
	8.5	OSF4008H
	10.0	OSF4010H
	11.5	OSF4011H
	13.0	OSF4013H
	15.0	OSF4015H

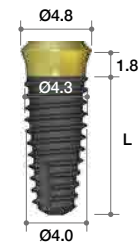

Regular Thread Ø4.5

- Healing Abutment(IRH503) included

Diameter(mm)	Length(mm)	Ref.C
Ø4.5	7.0	OSF4507H
	8.5	OSF4508H
	10.0	OSF4510H
	11.5	OSF4511H
	13.0	OSF4513H
	15.0	OSF4515H

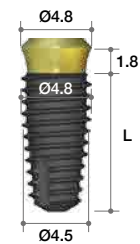

Regular Thread Ø5.0

- Healing Abutment(IRH503) included

Diameter(mm)	Length(mm)	Ref.C
Ø5.0	7.0	OSF5007H
	8.5	OSF5008H
	10.0	OSF5010H
	11.5	OSF5011H
	13.0	OSF5013H
	15.0	OSF5015H

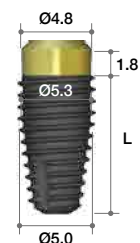

Deep Thread Ø4.5

- Healing Abutment(IRH503) included

Diameter(mm)	Length(mm)	Ref.C
Ø4.5	7.0	OSF4507DH
	8.5	OSF4508DH
	10.0	OSF4510DH
	11.5	OSF4511DH
	13.0	OSF4513DH
	15.0	OSF4515DH

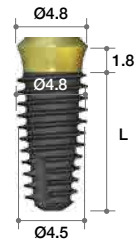

Deep Thread Ø5.0

- Healing Abutment(IRH503) included

Diameter(mm)	Length(mm)	Ref.C
Ø5.0	7.0	OSF5007DH
	8.5	OSF5008DH
	10.0	OSF5010DH
	11.5	OSF5011DH
	13.0	OSF5013DH
	15.0	OSF5015DH

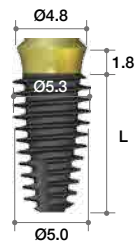

Closing Screw & Cover Screw & Healing Abutment

Closing Screw

- Used for two stage surgical protocol.
- Protects the inner portion and platform of the fixture after placing.
- Uses Hand Driver (1.2 Hex).
- Recommend torque : by hand (5 - 8Ncm)

Diameter(mm)	Height(mm)	Ref.C
Ø3.5	1.5	ICS200

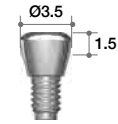

Cover Screw

- Used for two stage surgical protocol.
- Protects the inner portion and platform of the fixture after placing.
- Uses Hand Driver (1.2 Hex).
- Recommend torque : by hand (5 - 8Ncm)

Diameter(mm)	Height(mm)	Ref.C
Ø5.8	1.5	IRC100

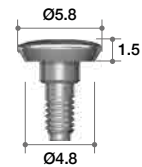

Healing Abutment

- Creates the emergence profile of the gingival tissue during healing.
- Uses Hand Driver (1.2 Hex).
- Recommend torque : by hand (5 - 8Ncm)

Diameter(mm)	Height(mm)	Ref.C
Ø5.8	2.0	IRH502
	3.0	IRH503
	4.0	IRH504

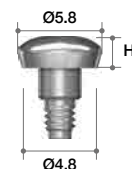

Abutment & Prosthetic Options

I. Abutment Level Prosthesis

1. Solid Abutment & Components

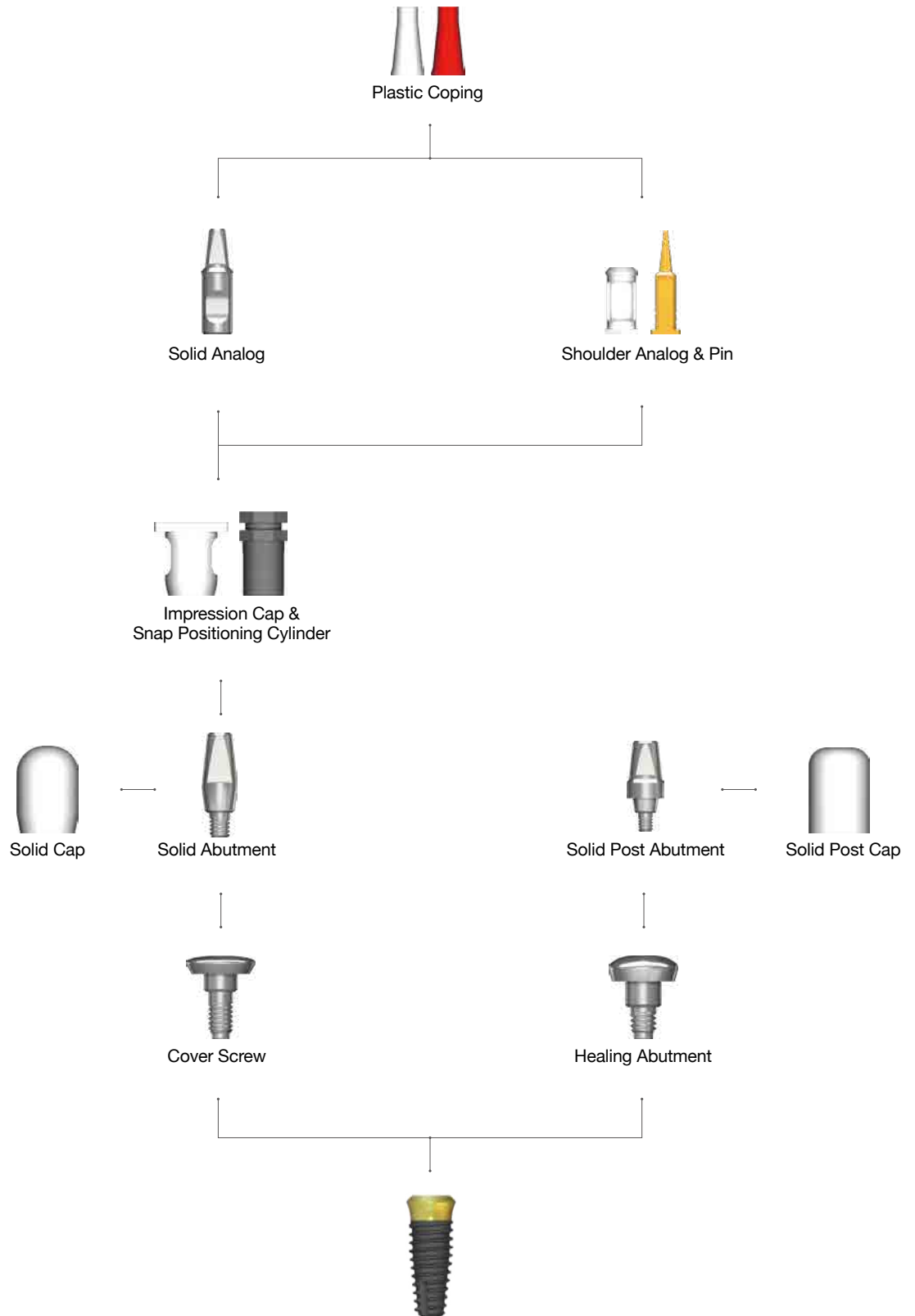

► Impression technique with Solid type

Solid Abutment

Solid Shoulder Analog & Analog Pin
 Shoulder Analog

- **Solid Abutment**
 - After the solid abutment is placed in the oral cavity, take an impression by using the Solid Impression Cap and the Solid Positioning Cylinder.
 - If Solid Abutment is not prepared, use the Solid Level Analog. However if it's prepared, use the Analog Pin and the Solid Shoulder Analog for accurate impression.

Solid Post Abutment

- **Solid Post Abutment**
 - Taking impression of the Solid Post Abutment follows the general method of rubber impression and production of a work model.

➔ Components for Solid Abutment (Continued)

Solid Abutment

- Solid Cap included

- Cement retained restoration only.
- Solid Abutment should be placed into patient's mouth before taking impression.
- Should be tightened with Solid Driver and Hand Driver.
- Recommend Torque : 35Ncm
- Post Height : 4.0, 5.5, 7.0mm

Profile Diameter	Post Height(mm)	Ref.C
Ø3.5	4.0	ISA400P
	5.5	ISA550P
	7.0	ISA700P

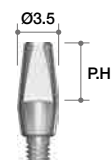

Solid Cap

- Protects a Solid Abutment and minimizes irritation to tongue and oral mucosa
- Easily make a temporary crown by resin build up
- Post Height : 4.0, 5.5, 7.0mm

Profile Diameter	Post Height(mm)	Ref.C
Ø5.7	4.0	ISPC450
	5.5	ISPC600
	7.0	ISPC750



Solid Post Abutment

- Solid Post cap included

- Cement retained restoration only.
- Solid Abutment should be placed into patient's mouth before taking impression.
- Should be tightened with Solid Driver and Hand Driver.
- Recommend Torque : 35Ncm
- Post Height : 4.0, 5.5, 7.0mm

Profile Diameter	Cuff Height(mm)	Post Height(mm)	Ref.C
Ø4.9	1	4.0	ISPA401P
	2		ISPA402P
	3		ISPA403P
	1	5.5	ISPA551P
	2		ISPA552P
	3		ISPA553P
	1	7.0	ISPA701P
	2		ISPA702P
	3		ISPA703P

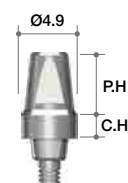

Solid Post Cap

- Protects a Solid Abutment and minimizes irritation to tongue and oral mucosa
- Easily make a temporary crown by resin build up
- Post Height : 4.0, 5.5, 7.0mm
- Cuff Height : 1, 2, 3mm

Profile Diameter	Cuff Height(mm)	Post Height(mm)	Ref.C
Ø4.9	1	4.0	ISPC401
	2		ISPC402
	3		ISPC403
	1	5.5	ISPC551
	2		ISPC552
	3		ISPC553
	1	7.0	ISPC701
	2		ISPC702
	3		ISPC703



➔ Components for Solid Abutment

Positioning Cylinder

- Can be engaged with Solid Abutment in impression

Height(mm)	Ref.C
9.2	IIPC100

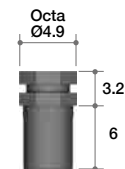

Impression Cap

- Impression components used when removing Solid Abutments

Profile Diameter	Ref.C
Ø5.7	ISIC100



Solid Analog

- Impression components used when removing Solid Abutment Shoulder Analog

Profile Diameter	Post Diameter	Post Height(mm)	Ref.C
Ø4.8	Ø3.5	4.0	ISN400
		5.5	ISN550
		7.0	ISN700

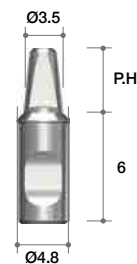

Shoulder Analog

- Impression components used when removing Solid Abutment
- Implement the platform part of the fixture in the process of modeling

Profile Diameter	Post Height(mm)	Ref.C
Ø4.8	10	ISLA100

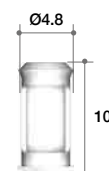

Shoulder Analog Pin

- Impression components used when removing Solid Abutment
- Can be engaged with Solid Shoulder Analog
- Components to prevent from fracturing in the process of modeling

Profile Diameter	Post Height(mm)	Ref.C
Ø3.5	7	ISLA200

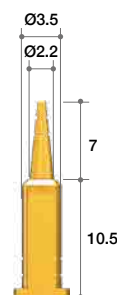

Plastic Coping

- Precisely plugged into post portion of Solid Abutment, Solid Post Abutment, and Lab Analog
- Offers easy wax up and accurate margins / clean burnout

Profile Diameter	Post Height(mm)	Type	Ref.C
Ø5.0	10.0	Single	ISPS100
		Bridge	ISPB100

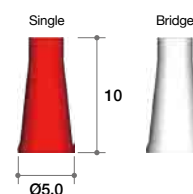

I. Abutment Level Prosthesis

2. Octa Abutment & Components

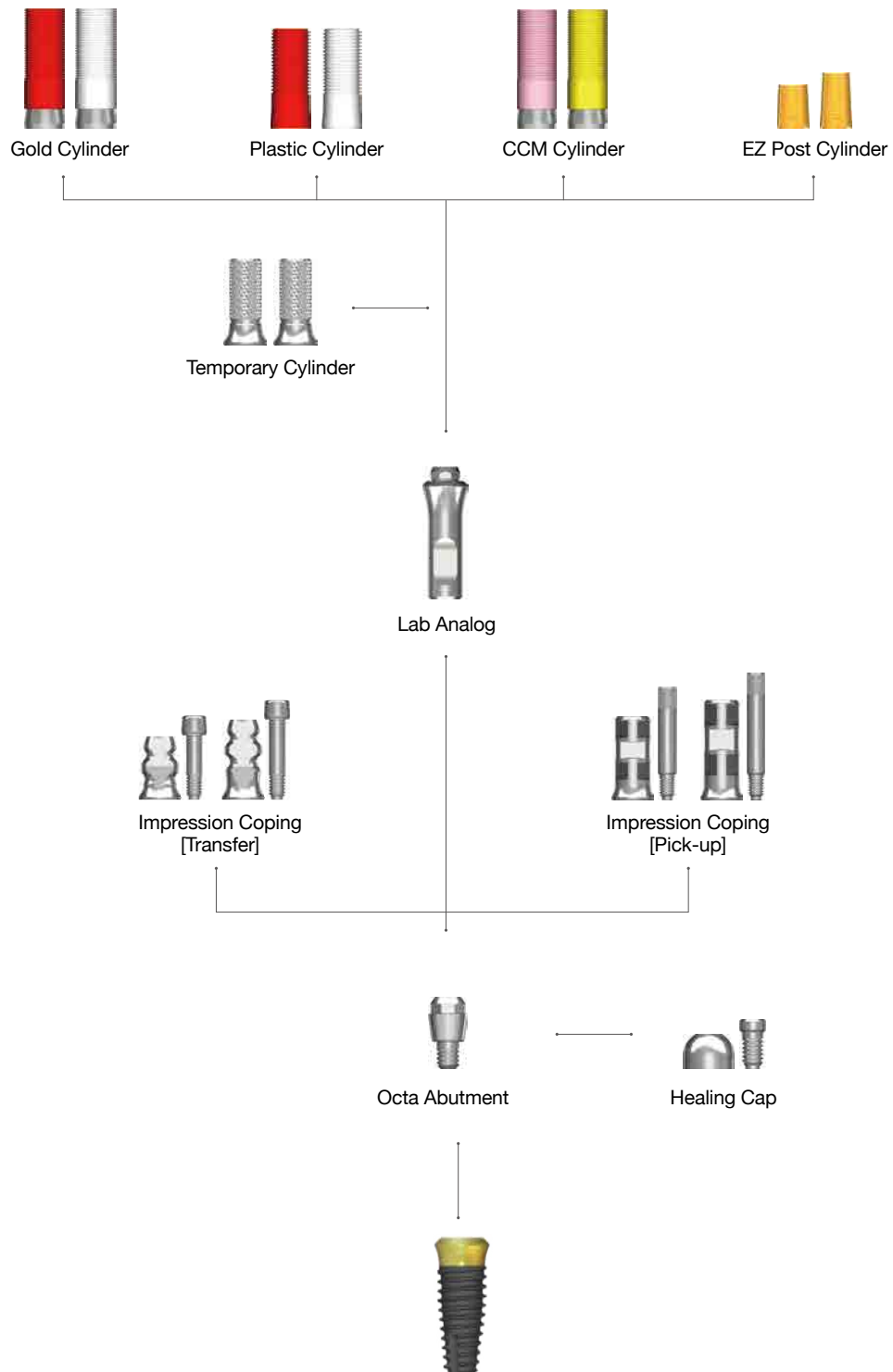

➔ Components for Octa Abutment

Octa Abutment

- Used to make multiple screw-retained prosthetics.
- Recommend Torque : 35Ncm
- Maximum path Angle : 70°

Profile Diameter	Ref.C
Ø3.5	IOA200

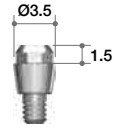

Healing Cap

- Cylinder Screw (IRCS200) included
- Protects Octa Abutment and minimizes irritation to tongue and oral mucosa.

Profile Diameter	Ref.C
Ø5.0	IHC400T



Impression Coping (Transfer)

- Guide Pin included
- Fasten with Impression Driver
- Can purchase the Guide Pin that can be tightened with 1.2mm Hex Driver separately

Profile Diameter	Height (mm)	Type	Ref.C
Ø5.0	7.5	Octa	AAOITO5010T
		Non-Octa	AAOITN5010T
Ø5.0	9.5	Octa	AAOITO5012T
		Non-Octa	AAOITN5012T



Impression Coping (Pick-up)

- Guide Pin included

Profile Diameter	Height (mm)	Type	Ref.C
Ø5.0	10.0	Octa	AAOIPO5010T
		Non-Octa	AAOIPN5010T
Ø5.0	12.0	Octa	AAOIPO5012T
		Non-Octa	AAOIPN5012T

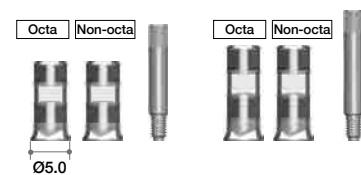

Lab Analog

- Use it with Snap Impression Coping in Impression which acquired when you create the Stone Model

Profile Diameter	Ref.C
Ø4.8	IOA300

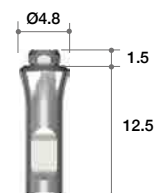

Temporary Cylinder

- Cylinder Screw (IRCS200) included
- Recommend torque : 25Ncm

Profile Diameter	Type	Ref.C
Ø5.0	Octa	AANOTCO5010T
	Non-Octa	AANOTCN5010T

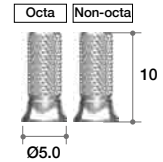

EZ Post Cylinder

- Cylinder Screw (IRCS200) included
- Recommend torque : 35Ncm

Profile Diameter	Post Height(mm)	Type	Ref.C
Ø5.0	5.5	Octa	AAOECO5005T
	7.0		AAOECO5007T
	5.5	Non-Octa	AAOECN5005T
	7.0		AAOECN5007T

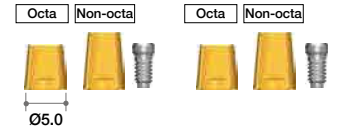

Gold Cylinder

- Cylinder Screw (IRCS200) included
- For customizing abutment for screw retained multi-unit restoration.
- Available in both octa(red) and non-octa(white)
- Melting point of gold alloy : 1063°C
- Threaded sleeves allow for better retention of resin or wax.
- Available in three diameters (Ø4.0, Ø5.0 & Ø6.0)
- Recommend torque : 30Ncm

Profile Diameter	Type	Ref.C
Ø5.0	Octa	IOGO100T
	Non-Octa	IOGN100T

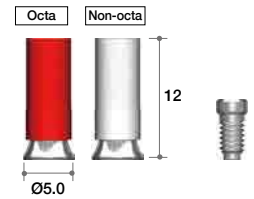

CCM Cylinder

- Cylinder Screw (IRCS200) included
- Threaded sleeves allow for better retention of resin or wax
- Octa(Pink), Non-Octa(Yellow)
- Available in three diameters (Ø4.0, Ø5.0 & Ø6.0)
- Melting temperature of CCM base: 1300~1400°C
- Recommend torque : 35Ncm
- Can be casted with non-precious alloys (Ni-Cr, Cr-Co alloys).

Profile Diameter	Type	Ref.C
Ø5.0	Octa	AANCCO5000T
	Non-Octa	AANCCN5000T

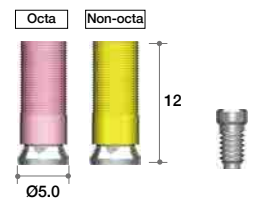

Plastic Cylinder

- Cylinder Screw (IRCS200) included
- Economical option
- For customizing abutment for screw retained multi-unit restoration
- Available in both octa(red) and non-octa(white)
- Threaded sleeves allow for better retention of resin or wax.
- Recommend torque : 25Ncm

Profile Diameter	Type	Ref.C
Ø5.0	Octa	IOPH100T
	Non-Octa	IOPN100T

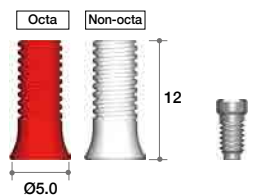

II. Fixture Level Prosthesis

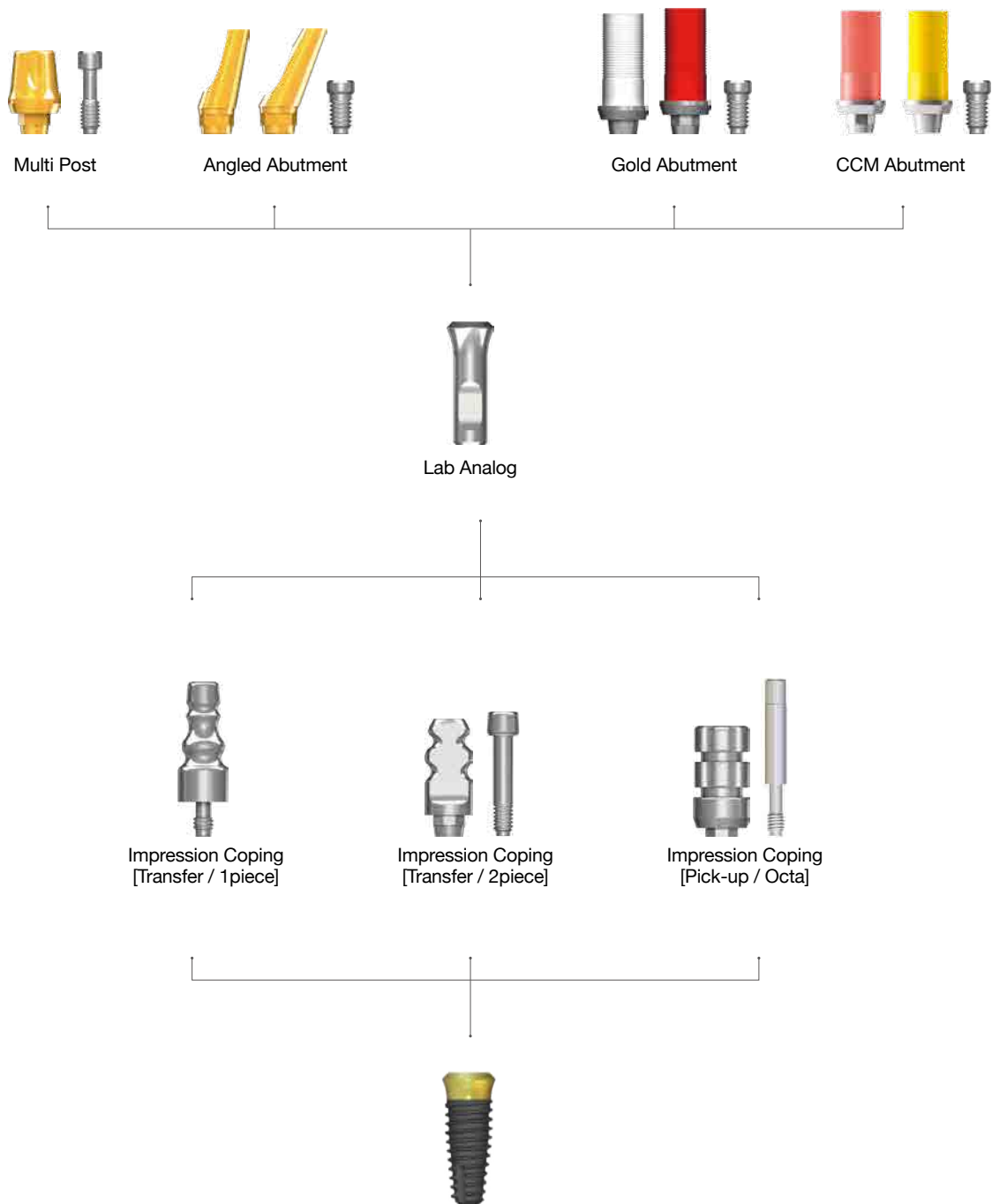

➔ Abutment Options (Continued)

Multi Post

- Multi Post Screw (EXIMS100) included
- Cement Retained Restoration
- Post Height : 6.5mm
- The anodizing part is located below the Tissue to provide an aesthetic design
- Recommended Torque : 35Ncm

Diameter	Height(mm)	Ref.C
Ø5.5	6.5	EXIM001T

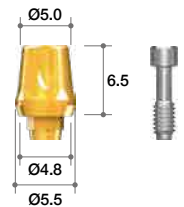

Multi Post Cap

- Protects Multi Post and minimizes discomfort of oral cavity

Height(mm)	Ref.C
5.7	EXIMC100



Angled Abutment

- Abutment Screw (IAAS600) included
- Two different angulations. (15°, 25°)
- Minimized screw head length needs minimum height to prevent milling problems
- Recommended Torque : 35Ncm

Diameter	Height (mm)	Angle	Ref.C
Ø3.7	6.5	15°	IAA3515T
		25°	IAA3525T

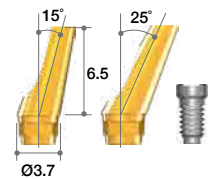

Gold Abutment

- Abutment Screw (EXIMS100) included
- Useful to make a customized abutment in difficult situations
- Octa (Red) and Non-Octa (White)
- Melting point of gold alloy : 1063°C
- Threaded sleeves allow for better retention of resin or wax
- Recommended Torque : 30Ncm

Diameter	Sleeve Color Vision	Type	Ref.C
Ø5.5	White	Non-Octa	EXIGA100T
	Red	Octa	EXIGA200T

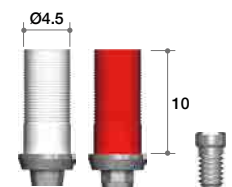

➡ Abutment Options (Continued)

CCM Abutment

- Abutment Screw(EXIMS100) 포함

- Useful to make a customized abutment in difficult situations
- Octa (Pink), Non-Octa (Yellow)
- Can be casted with non-precious alloys (Ni-Cr, Cr-Co alloys).
- Threaded sleeves allow for better retention of resin or wax
- Melting point of CCM : 1300~1400°C
- Recommended Torque : 35Ncm

Profile Diameter	Type	Ref.C
Ø5.5	Octa	ICA5512OT
	Non-Octa	ICA5512NT

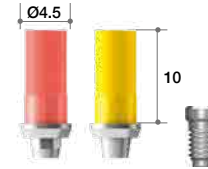

Impression Coping (Transfer Type)

- 2 Piece Type and Guide Pin (REIG150) included

- One Piece(Non-Octa), Two Piece(Octa)
- 2 Different Heights
- Used for Closed Tray(Transfer) Technique
- Easy & Accurate Fixture Position Transfer
- Flat Surface fits well with the Hex in the Fixture
- Use Transfer Impression Coping driver and Hand Driver (1.2 hex) to tighten Impression Coping accurately
- Guide Pin which should be tightening by 1.2 Hex Driver can be purchased separately

Profile Diameter	Height (mm)	Type	Ref.C
Ø4.8	12mm	1 Piece	EIITN5012
	16mm		EIITN5016
	12mm		EIITN5012H
	16mm		EIITN5016H
	9.5mm	2 Piece	EIITO5012T
	13.5mm		EIITO5016T
	9.5mm		EIITO5012HT
	13.5mm		EIITO5016HT

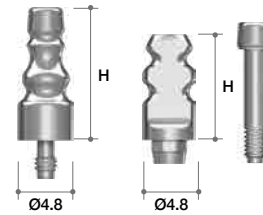

Impression Coping (Pick-up Type)

- Guide Pin (EXICG100) included

- Recommended to use for multiple case
- Square Body Design guarantees stability with in the impression and transfers the fixture position accurately
- Guide Pin which should be tightening by 1.2 Hex Driver can be purchased separately

Profile Diameter	Height (mm)	Type	Ref.C
Ø5.5	10mm	Octa	EXIC001T



Lab Analog

- Used instead of Fixture in Impression

Profile Diameter	Ref.C
Ø4.8	EXIA001



NEW PRODUCT

III. Overdenture Prosthesis

1. MegaGen Overdenture System

Meg-Loc

Compatible with products L and K, excellent functionality, & incomparable price!

Combination of Titanium housing and Pekkton (reinforced plastic) creates low water solubility and higher wear resistance and durability than other existing products.

Retention insert offers wide range of retention forces (600gf, 1200gf, 1800gf) to suit each patient, resulting in high level of satisfaction for both patient and dentist.

Strong physical properties of Pekkton and insert gap increase elasticity, so that insert does not tear or break unlike conventional nylon products, thereby ensuring strong retention and longer life.



Meg-Ball

Smallest housing, retentive ring with longer life!

Even when the implant angle is not parallel, a stable denture can still be produced!

Compatible with other products with Ø2.25 head size, minimized patient inconvenience due to small-size housing, simpler to arrange artificial teeth as space occupied by denture is reduced, and easier to maintain than other systems.

Retentive ring has a high elasticity, abrasion resistance, and durability, thereby doubling the length of life when compared to a silicone O-ring and guaranteeing a longer life than NBR products.

Positioner (0/5/10/15 degrees) maintains parallel housing direction, even with distorted implant placement angle, ensuring denture stability.

Meg-Magnet

Designed to maintain stable and sufficient magnetic force!

Completely blocks bursts and corrosion resistant!

Structure is connected with abutment using magnetic force, which is feasible even with insufficient bone volume or poor bone quality

Easy to attach and detach, and minimal inflammation.

Magnet of Ø4.5 & Ø5.0 is compatible with other products, and laser marking on upper part makes it easy to distinguish between up and down.

Sufficient magnetic force (450gf, 650gf) ensures stable retention

Laser sealing blocks any bursting phenomenon.

TiN coating provides corrosion resistance.

Positioner (small & regular) prevents magnet from slipping in the mouth and stops any flow of impression materials under the abutment.



NEW PRODUCT

III. Overdenture Prosthesis

1. Meg-Loc Abutment & Component



Meg-Loc Metal Housing set



Block-out Spacer



Meg-Loc Abutment



➔ Meg-Loc Overdenture System

Meg-Loc Abutment

- Angle compensation to one side 20 ° (both sides 40 °)
- Gently rounded shape
- Compatible with 1.2 Hex Driver
- **Recommend torque : 35Ncm**

Cuff Height (mm)	Ref.C
0	MLOO00
1.0	MLOO01
2.0	MLOO02
3.0	MLOO03
4.0	MLOO04
5.0	MLOO05
6.0	MLOO06

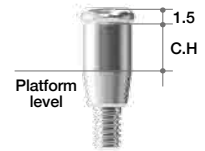

Meg-Loc Package

- 1 Meg-Loc Abutment

* Following package items are delivered with San DreMetto Korea packaging.

- 1 Titanium Housing
- 1 Block Out Spacer
- 4 Pekkton Retention Inserts (Gray-250~300gf(for lab), Yellow-600gf, Red-1200gf, Mint-1800gf)

Cuff Height (mm)	Ref.C
0	MLOO00P
1.0	MLOO01P
2.0	MLOO02P
3.0	MLOO03P
4.0	MLOO04P
5.0	MLOO05P
6.0	MLOO06P



Meg-Loc Attachment

Description	QTY	Ref.C
CM-LOC Attachment	SET	CM-LOC
Housing Titanium® for Pekkton® Inserts	4EA	CM-LOC-TP
Processing Insert (extra-low)	4EA	CM-LOC-PI
Insert (extra-low)	4EA	CM-LOC-EL
Insert (low)	4EA	CM-LOC-L
Insert (medium)	4EA	CM-LOC-M
Block-out Spacer	4EA	CM-LOC-BS

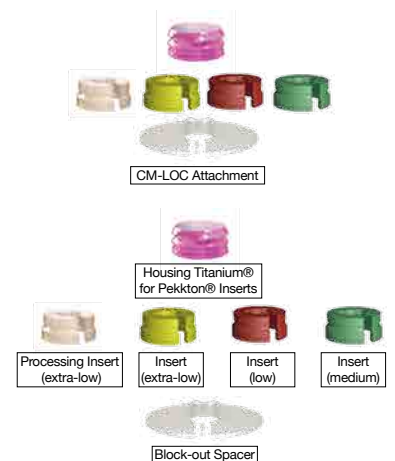

Multi Tool

- Retention insert Insert & Remove Tool

Ref.C
MLMT



III. Overdenture Prosthesis

2. Meg-Ball Abutment & Component



➔ Meg-Ball Overdenture System

Meg-Ball Abutment

- Angle compensation to one side 15 ° (both sides 30 °)
- Ø2.25 Ball shape
- Recommend torque : 35Ncm

Cuff Height (mm)	Ref.C
0	MBOO00
1.0	MBOO10
2.0	MBOO20
3.0	MBOO30
4.0	MBOO40
5.0	MBOO50
6.0	MBOO60

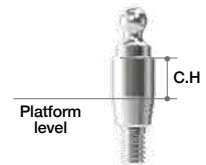

Meg-Ball Package

- Composed of Meg-Ball Abutment/ Metal Housing Set/ Housing Positioner (0°,5°,10°,15°)

Cuff Height (mm)	Ref.C
0	MBOO00P
1.0	MBOO10P
2.0	MBOO20P
3.0	MBOO30P
4.0	MBOO40P
5.0	MBOO50P
6.0	MBOO60P



Meg-Ball Metal Housing Set

- 1 Metal Housing
- 1 Retentive Ring

Ref.C
MBHR



Retentive Ring Set

Quantity	Ref.C
5	MBR5
10	MBR10



III. Overdenture Prosthesis

3. Meg-Magnet Abutment & Component



➔ Meg-Magnet Overdenture System

Meg-Magnet Abutment

- Use to 1.2 Hex Driver
- Recommend torque : 35Ncm

Profile Diameter	Cuff Height (mm)	Ref.C
Ø4.5	1.0	MMOO410
	2.0	MMOO420
	3.0	MMOO430
	4.0	MMOO440
	5.0	MMOO450
	6.0	MMOO460
Ø5.0	1.0	MMOO510
	2.0	MMOO520
	3.0	MMOO530
	4.0	MMOO540
	5.0	MMOO550
	6.0	MMOO560

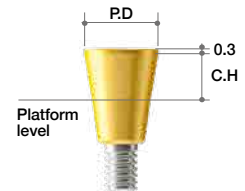

Meg-Magnet Package

- 1 Meg-Magnet Abutment
- 1 Magnet (Ø4.5-450gf, Ø5.0-650gf)
- 1 Magnetic Positioner

Profile Diameter	Cuff Height (mm)	Ref.C
Ø4.5	1.0	MMOO410P
	2.0	MMOO420P
	3.0	MMOO430P
	4.0	MMOO440P
	5.0	MMOO450P
	6.0	MMOO460P
Ø5.0	1.0	MMOO510P
	2.0	MMOO520P
	3.0	MMOO530P
	4.0	MMOO540P
	5.0	MMOO550P
	6.0	MMOO560P



Meg-Magnet Attachment Set

Size	Ref.C
Small	MA402
Regular	MA502

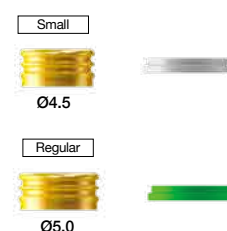

AnyOne Surgical Kit

I. AnyOne OneStage Kit

Ref.C
KA0IN3003

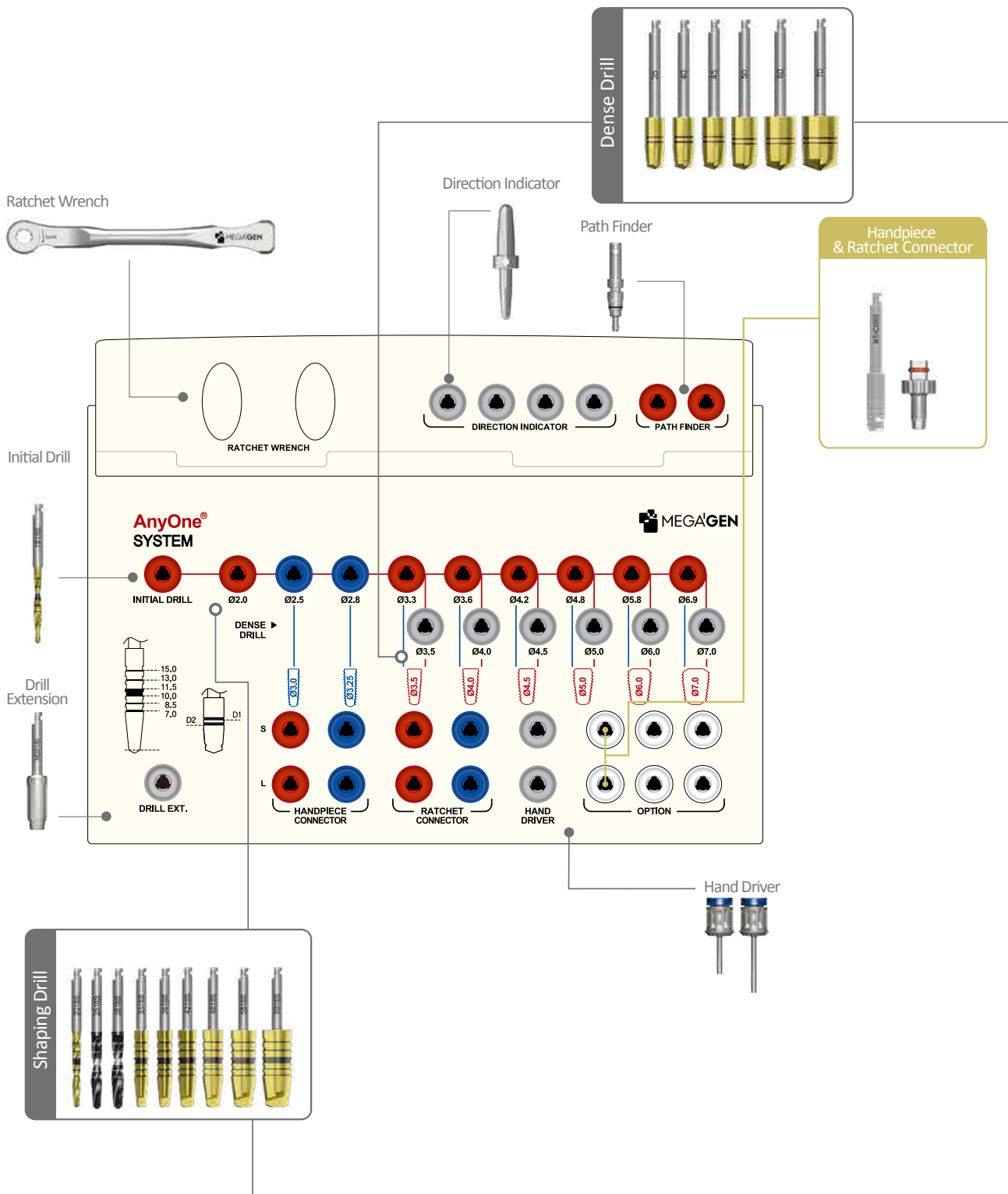

Shaping Drill

- Each drill has depth marking lines from 7.0mm to 15.0mm
- The dual marking system (grooves and laser markings) provides visual and radio graphic depth verification during surgery.

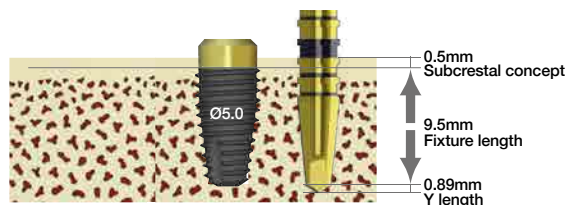

Drill Diameter	Ø2.8	Ø3.3	Ø3.6	Ø4.2	Ø4.8	Ø5.8	Ø6.9
Y length	0.58	0.59	0.68	0.85	0.89	0.94	0.94

※ Actual drill length : Drill length does not normally include the Y dimension of the drill.

※ Markings on the Shapping Drill are 0.5mm longer than the fixture so fixtures will automatically be placed 0.5mm subcrestally if the drilling protocol is followed.

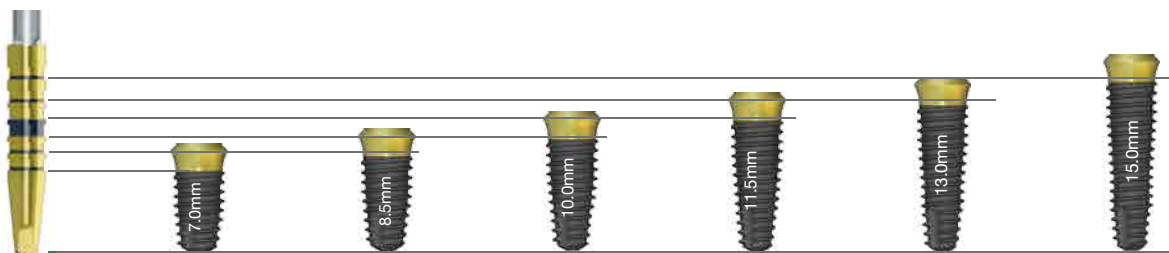

※ To place a Ø5.0 x 10mm length fixture, the required bone depth would be 10.89mm.
For example : 0.5mm(subcrestal concept) + 0.89mm(Y dimension of drill tip) + 9.5mm (fixture length)

Dense Drill

- To control initial stability in dense bone (type I & II), use the Dense Drill to remove and shape the cortical bone.

D2 Bone

In type II bone, drill to the first line.

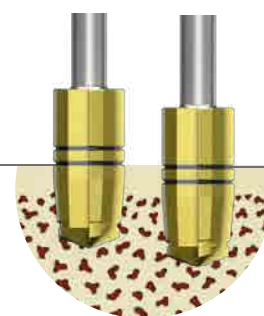

D1 Bone

In type I bone, drill to the second line.

► ► Surgical drilling sequence

- AnyOne fixtures offer optimum initial stability when they are used with the following drill sequence guide, AnyOne implants should be placed 0.5mm subcrestally.

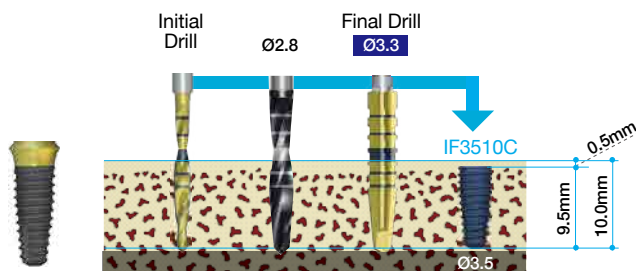

Ø3.5 Fixture

Ø3.5 drilling sequence

10.0mm is the fixture length, The Shaping Drills are 0.59mm longer than the fixture, so total drill depth is 10.59mm.

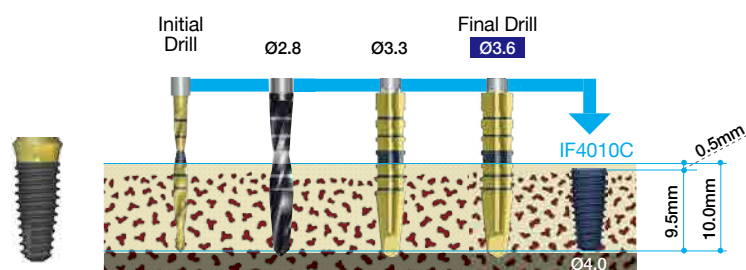

Ø4.0 Fixture

Ø4.0 drilling sequence

10.0mm is the fixture length, The Shaping Drills are 0.68mm longer than the fixture, so total drill depth is 10.68mm.

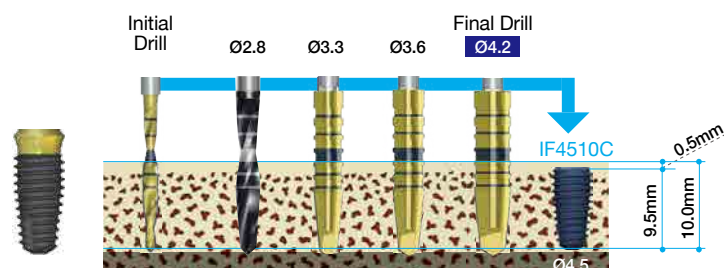

Ø4.5 Fixture

Ø4.5 drilling sequence

10.0mm is the fixture length, The Shaping Drills are 0.85mm longer than the fixture, so total drill depth is 10.85mm.

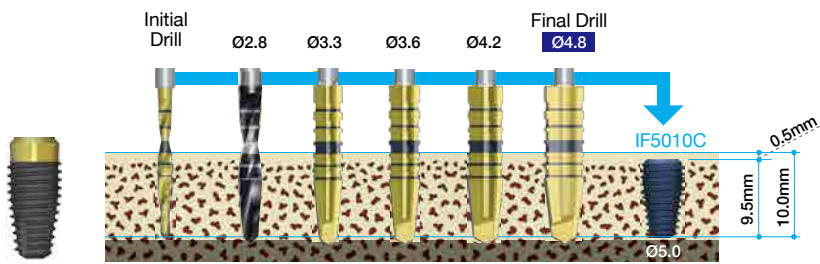

Ø5.0 Fixture

Ø5.0 drilling sequence

10.0mm is the fixture length, The Shaping Drills are 0.89mm longer than the fixture, so total drill depth is 10.89mm.

▶▶ Handpiece & Ratchet Connector

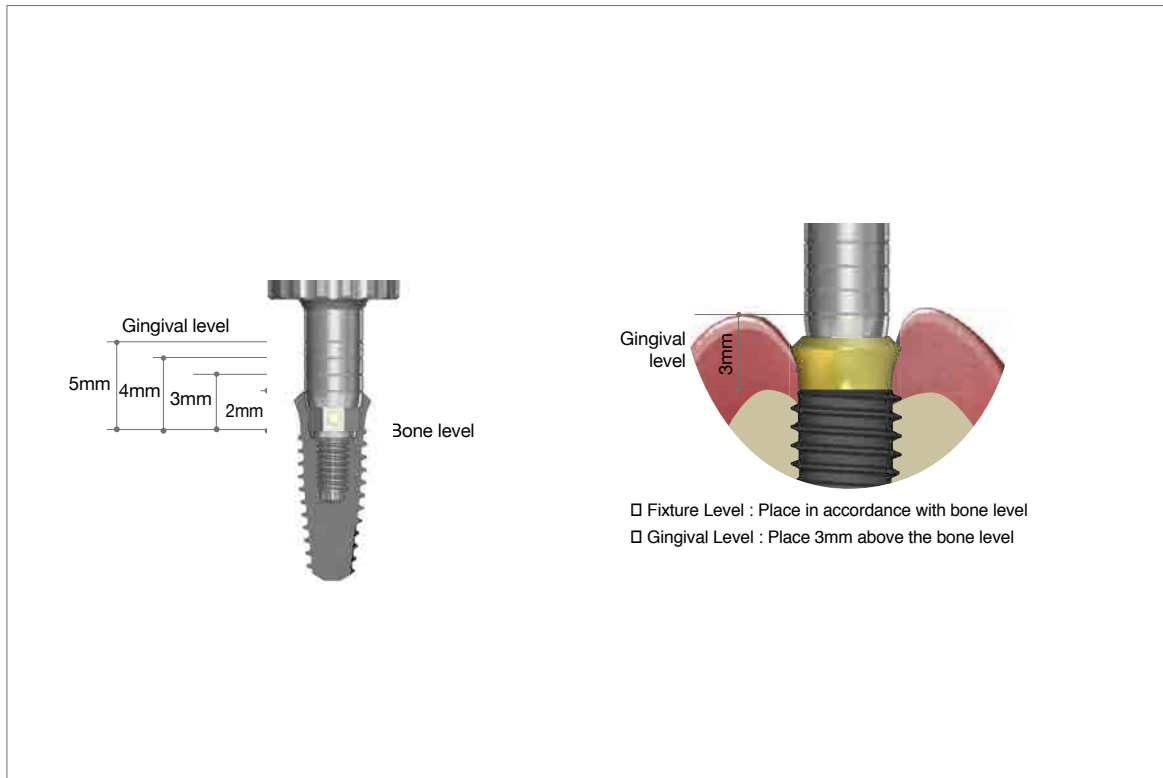

➔ Surgical Kit Components (Continued)

Initial Drill

- Used to pierce the cortical bone initially.
- Advisable to go into the bone to the full length of a fixture.

Diameter	Length(mm)	Ref.C
Ø1.8	33	ID1818S
	38	*ID1818M
	43	*ID1818L

(*) Separate sales item.



Shaping Drill

- Each drill has depth marking lines from 7.0mm to 15.0mm.
- The dual marking system(grooves and laser markings) provides visual and radiographic depth verification during surgery.
- TiN coating on drills : Enhanced corrosion resistance and abrasion resistance.

Diameter	Length(mm)	Ref.C
Ø2.0	33	SD2018S
	38	*SD2018M
	43	*SD2018L
Ø2.5	33	SD2518S
	38	*SD2518M
	43	*SD2518L
Ø2.8	33	SD2818S
	38	*SD2818M
	43	*SD2818L
Ø3.3	33	SD3318S
	38	*SD3318M
	43	*SD3318L
Ø3.6	33	SD3618S
	38	*SD3618M
	43	*SD3618L
Ø4.2	33	SD4218S
	38	*SD4218M
	43	*SD4218L
Ø4.8	33	SD4818S
	38	*SD4818M
	43	*SD4818L
Ø5.8	33	SD5818S
	38	*SD5818M
	43	*SD5818L
Ø6.9	33	SD6918S
	38	*SD6918M
	43	*SD6918L

(*) Separate sales item.

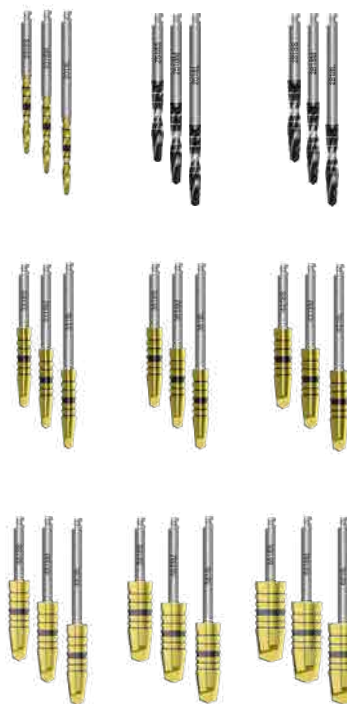

Dense Drill

- Used to remove and shape cortical bone to control initial stability in dense bone (type I & II).
- TiN coating on drills : Enhanced corrosion resistance and abrasion resistance.

Diameter	Type	Ref.C
Ø3.9	Long	DD39
Ø4.3		DD43
Ø4.8		DD48
Ø5.3		DD53
Ø6.3		DD63
Ø7.3		DD73



➔ Surgical Kit Components (Continued)

Handpiece Connector

- Used with Handpiece to remove fixture from ampule and to place the fixture.
- Spring type connection allows for easy and secure pick-up and positioning of the fixture.
- First mark on the shaft indicate the position of the fixture platform, For second mark, the bottom of the black line is 3mm and the top of the black line is 4mm(from fixture platform).
- Especially useful in flapless surgery.

AnyOne Internal& External

Length(mm)	Type	Connection	Ref.C
5	*Ultra-short	Hex. 2.5	HCU25
10	Short		HCS25
15	Long		HCL25

(*) Separate sales item

MiNi

Length(mm)	Type	Connection	Ref.C
10	Short	Hex. 1.7	HCS17
15	Long		HCL17

OneStage

Length(mm)	Type	Connection	Ref.C
6	*Ultra-short	Octa. 3.1	MTHC200U
9	Short		MTHC200S
16	Long		MTHC200L

(*) Separate sales item

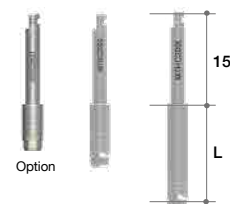
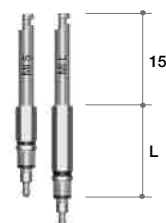
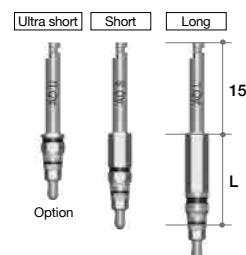

Ratchet Connector

- Used for inserting or removing a fixture with the Ratchet Wrench.
- Check to make sure the Ratchet Connector is completely seated into the Ratchet Wrench before using.
- Excessive force can cause damage to internal hex of fixture.
- Marks on the shaft indicate the position of fixture platform. Bottom of the black line is 3mm and top of black line is 4mm(from fixture platform).
- Especially useful in flapless surgery.

Internal& External

Length(mm)	Type	Connection	Ref.C
10	*Ultra-short	Hex. 2.5	RCU25
15	Short		RCS25
20	Long		RCL25

(*) Separate sales item

MiNi

Length(mm)	Type	Connection	Ref.C
15	Short	Hex. 1.7	RCS17
20	Long		RCL17

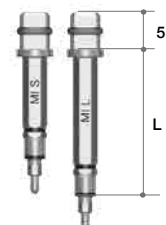
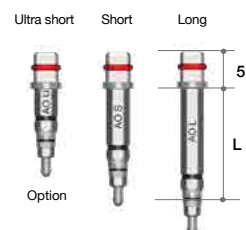

Final Driver

- Used to attach or remove the fixture by connecting to Ratchet Wrench
- Used to mount the Ratchet Connector fully on the Ratchet Wrench

OneStage

Length(mm)	Type	Connection	Ref.C
6	Short	Octa. 3.1	MOHD310S
13	Long		MOHD310



Hand Driver (1.2 Hex)

- Used for all Cover Screws, Abutment Screws, and Healing Abutments.
- Available in 4 lengths for added convenience.
- Hand Driver can be directly inserted into the Torque Wrench without using an adaptor.
- Hex tip can withstand 35-45Ncm of torque without distorting.

Length(mm)	Type	Ref.C
5	*Ultra-short	TCMHDU1200
10	Short	TCMHDS1200
15	Long	TCMHDL1200
20	*Extra-long	TCMHDE1200

(*) Separate sales item



Hand Driver (0.9 Hex)

- Used for AnyOne External fixture cover screw.
- Available in 3 lengths for convenience.
- Hand Driver can be directly inserted into the Torque Wrench without using an adaptor.
- Hex tip can withstand 25-35Ncm of torque without distorting.

Length(mm)	Type	Ref.C
5	*Ultra-short	TCMHDU0900
10	Short	TCMHDS0900
15	Long	TCMHDL0900

(*) Separate sales item



Drill Extension

- No more than 35Ncm torque : May distorted when excessive force is applied.
- Extends drills & other handpiece instruments.

Ref.C
MDE150



➔ Surgical Kit Components

Direction Indicator

- Confirms drilling direction and functions as a parallel guide for additional osteotomies.
- Each end of the Direction Indicator has a different diameter
 - Ø2.0 and Ø2.8.

Diameter	Ref.C
Ø2.0 / Ø2.8	MDI100



Path Finder

- After the fixture is placed, a Path Finder may be connected into the fixture and function as a parallel guide for additional osteotomies.
- Grooves indicate the distance from the fixture platform. The first groove is 0.3mm and the second groove is 1mm, especially useful in flapless surgery.

Length(mm)	Ref.C
15	PF

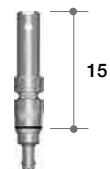

Ratchet Wrench

- Used to exert more force than the Handpiece.
- No bearing system : No breakage and no corrosion problems.
- Arrow laser marking indicates direction of force.

Ref.C
MRW040S



II. AnyOne Stopper Drill Kit

AnyOne Stopper Drill Kit helps to drill safely and conveniently to a desired depth.

Ref.C
KAOSS3000

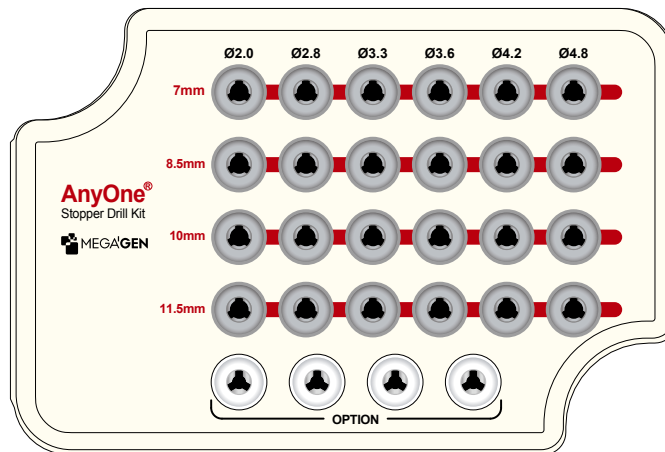

Stopper Drill

Diameter	Length(mm)	Ref.C
Ø2.0	7	SD2007M
	8.5	SD2008M
	10	SD2010M
	11.5	SD2011M
Ø2.8	7	SD2807M
	8.5	SD2808M
	10	SD2810M
	11.5	SD2811M
Ø3.3	7	SD3307M
	8.5	SD3308M
	10	SD3310M
	11.5	SD3311M
Ø3.6	7	SD3607M
	8.5	SD3608M
	10	SD3610M
	11.5	SD3611M
Ø4.2	7	SD4207M
	8.5	SD4208M
	10	SD4210M
	11.5	SD4211M
Ø4.8	7	SD4807M
	8.5	SD4808M
	10	SD4810M
	11.5	SD4811M
*Ø5.8	7	SD5807M
	8.5	SD5808M
	10	SD5810M
	11.5	SD5811M
*Ø6.9	7	SD6907M
	8.5	SD6908M
	10	SD6910M
	11.5	SD6911M



(*) Separate sales item.

III. AnyOne Prosthetic Kit

Ref.C
MPK3000

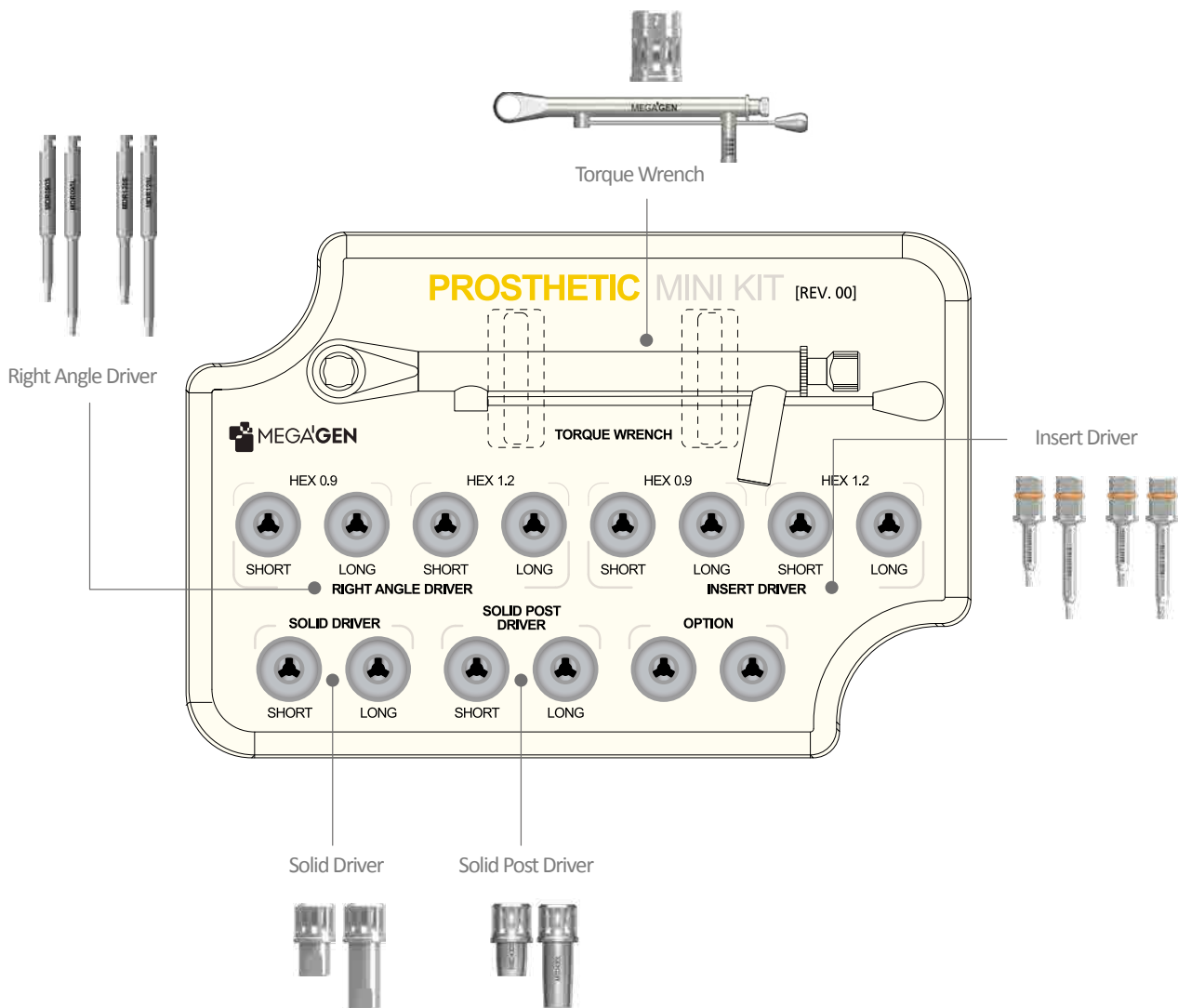

➔ Prosthetic kit Components

Right Angle Driver (hex 0.9)

- Can be engaged with Cover Screws, Abutment Screws and Healing Abutment
- Hex tip has been designed to stand Torque force of 35~45 Ncm
- Used for AnyOne External

Length(mm)	Type	Ref.C
4	*Ultra-short	MDR090SS
10	Short	MDR090S
15	Long	MDR090L

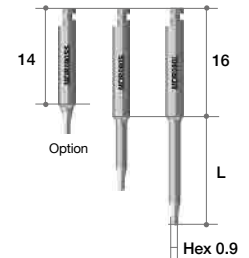

Right Angle Driver (hex 1.2)

- Can be engaged with Cover Screws, Abutment Screws and Healing Abutment
- Hex tip has been designed to stand Torque force of 35~45 Ncm
- Used for AnyOne Internal & External

Length(mm)	Type	Ref.C
4	*Ultra-short	MDR120SS
10	Short	MDR120S
15	Long	MDR120L
20	*Extra Long	MDR120EL

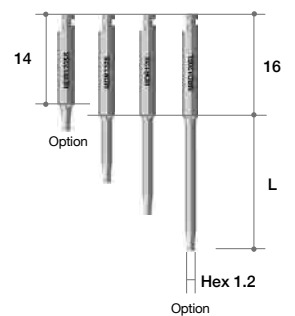

Insert Driver (hex 0.9)

- Can be engaged with Cover Screws, Abutment Screws and Healing Abutment
- Hex tip has been designed to stand Torque force of 35~45 Ncm

Length(mm)	Type	Ref.C
10	Short	MID090S
15	Long	MID090L

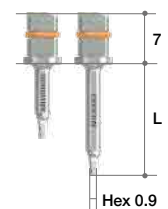

Insert Driver (hex 1.2)

- Can be engaged with Cover Screws, Abutment Screws and Healing Abutment
- Hex tip has been designed to stand Torque force of 35~45 Ncm

Length(mm)	Type	Ref.C
10	Short	MID120S
15	Long	MID120L

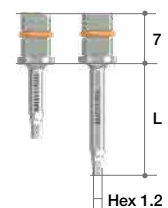

Solid Driver

- Can be engaged with Solid Abutment
- Connected to Torque Wrench as well
- Offers various options of Length (6mm / 12mm)

Diameter	Length(mm)	Type	Ref.C
Ø3.4	6	Short	MSD300S
	12	Long	MSD300L



Solid Post Driver

- Can be engaged with Solid Abutment
- Connected to Torque Wrench as well
- Offers various options of Length (6mm / 12mm)

Diameter	Length(mm)	Type	Ref.C
Ø4.3	6	Short	MSD430S
	12	Long	MSD430L



IV. AnyOne Bone Profiler Kit

Ref.C
 KAOBP3000

Removes the overhanged bone around a fixture to allow adequate seating of a Healing Abutment or a Prosthetic Abutment.

- Place a Guide Pin into a fixture and choose a Bone Profiler which fits with the situation.
- Four different sizes of bone profiler and four guide pins are included in the kit.

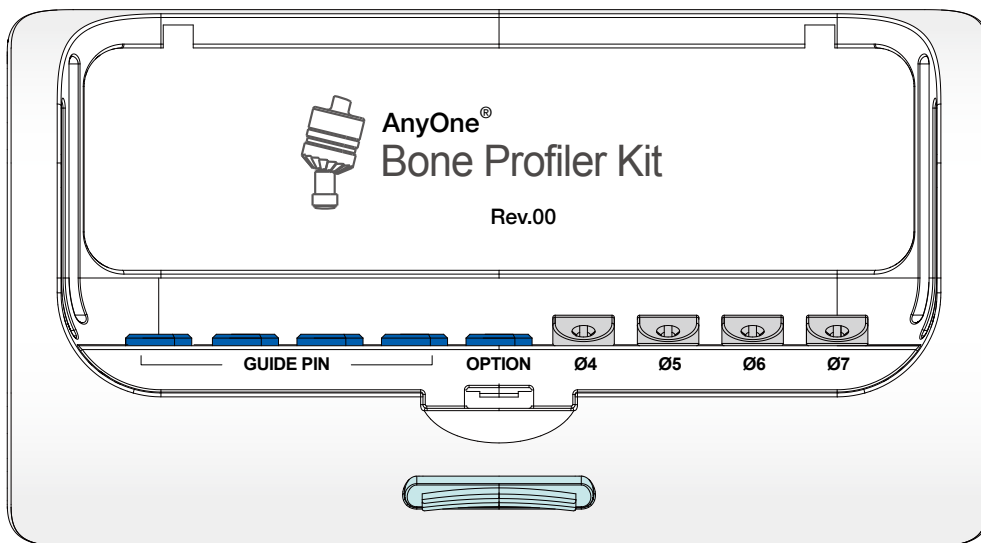

Bone Profiler

- Guide Pin(BPGP2) included.

- Each bone profiler can be purchased separately for refill.
- Each package includes a bone profiler and a guide pin.

Profile Diameter	Length (mm)	Ref.C
Ø4	13	AOBP40G
Ø5		AOBP50G
Ø6	8	AOBP60G
Ø7		AOBP70G



V. Optional components (Continued)

- not included in a surgical kit
- may be purchased separately and placed in the spaces provided in the surgical kit

Lindermann Drill

- Cross cut on the drill.
- Can correct the path during drilling.

Diameter(mm)	Ref.C
2	TEEL200M



Hand Tap

- Useful when the internal screw of the Fixture has been damaged
- For Re-tapping the disabled thread
- It can even more damage the thread when excessive force is applied when Re-tapping. Therefore it is recommended to apply the force slowly and gradually
- M1.6 can be used for AnyOne's External fixtures with Small Sizes

Length(mm)	Type	Ref.C
10	M1.6	THT160L
	M2.0	THT200L



V. Optional components (Continued)

Tissue Punch

- Customized to remove soft tissue using osteotomy socket and useful for flapless surgery
- Easy to identify the thickness of soft tissue by comparing the tissue with the laser marking on the height of 2mm
- Can minimize the loss of soft tissue when conducting a flapless surgery
- Can stop from bleeding when used with Healing Abutment

Diameter	Marking	Ref.C
In. Ø3 / Out. Ø4	2mm	TCMTPM0304
In. Ø4 / Out. Ø5		TCMTPM0405
In. Ø5 / Out. Ø6		TCMTPM0506
In. Ø6 / Out. Ø7		TCMTPM0607
In. Ø7 / Out. Ø8		TCMTPM0708

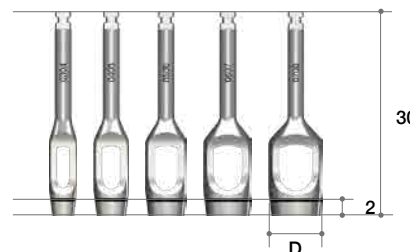

Flattening Drill

- Flattens the irregular bone and enables the stopper drill to drill the exact depth
- Designed to be engaged with Flattening Lance and Housing. There are 2 kinds of Housing to match the diameters of different final drills. (Ø5.0 & Ø6.0)
- Ø5.0 = Stopper Drill Ø2.0 ~ Ø4.3
- Ø6.0 = Stopper Drill Ø4.8 ~ Ø5.4
- By using Housing Boundary of the path is formed and it becomes the barometer of the drilling position for the next fixture

Diameter	Length(mm)	Ref.C
Ø5.0 / Ø2.0	3.5	FD5020
Ø6.0 / Ø2.0		FD6020

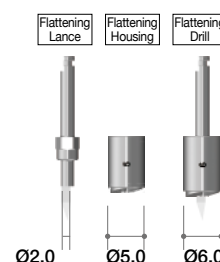

1

• Use Flattening Drill to make drilling on the right fixture position
(If the Final drill's diameter is from Ø2.0~Ø4.3, use Ø5.0 Housing and in case the diameter is Ø4.8, Ø5.4 use Ø6 Housing.)

2

• Start drilling sequence below considering the size of fixtures to place and the bone density

3

• Start placing the fixtures using Handpiece & Ratchet Connector

Trephine Bur

- Minimizes the drilling steps needed, especially for wider fixtures.
- Helpful for collecting autogenous bone.
- Useful for removing failed and fractured fixtures.
- Depth markings are 7, 8.5, 10, 11.5, 13mm, same depths as fixtures. (No Y dimension so markings are actual length).
- Markings on the drill shaft represent the inside / outside diameter of Trephine Burs.

Diameter	Type	Ref.C
Ø3.5 (in Ø2.5)	Short (32mm)	TANTBL2535
Ø5.0 (in Ø4.0)		TANTBL4050
Ø6.0 (in Ø5.0)		TANTBL5060
Ø7.0 (in Ø6.0)		TANTBL6070
Ø3.5 (in Ø2.5)	Long (38mm)	TANTBE2535
Ø5.0 (in Ø4.0)		TANTBE4050
Ø6.0 (in Ø5.0)		TANTBE5060
Ø7.0 (in Ø6.0)		TANTBE6070

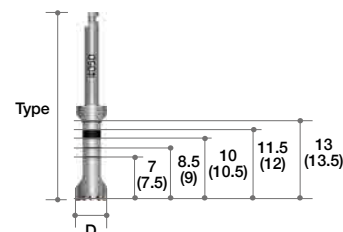

Trephine Bur Stopper

- Controls the depth of trephination with a Stopper placed into the Trephine.
- Especially useful in cases with limited available bone from important anatomy.

Length (mm)	Ref.C
7.0	TANTSF2307
8.5	TANTSF2308
10.0	TANTSF2310
11.5	TANTSF2311

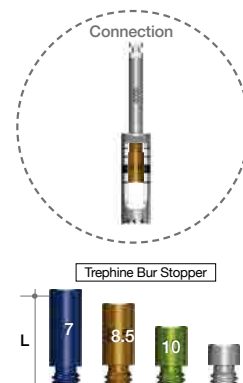

Bottom Drill

- It removes remaining bone in osteotomy socket after trephine drilling.
- It imprints the sizes of fixtures, for example 7, 8.5, 10, 11.5 and 13mm, by laser marker.

Diameter	Type	Ref.C
Ø3.3	Short (32mm)	TCMBDS33
Ø3.8		TCMBDS38
Ø4.8		TCMBDS48
Ø5.8		TCMBDS58
Ø6.8		TCMBDS68
Ø3.3	Long (38mm)	TCMBDL33
Ø3.8		TCMBDL38
Ø4.8		TCMBDL48
Ø5.8		TCMBDL58
Ø6.8		TCMBDL68

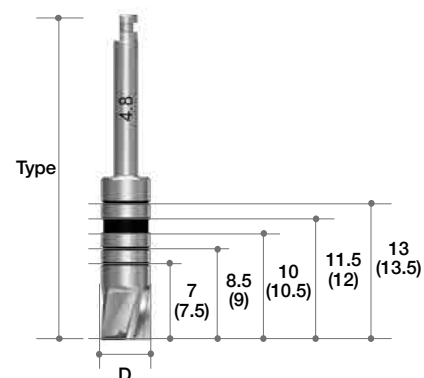

V. Optional components (Continued)

Reamer Drill & Center Pin

- Removes inner lip of the cast after casting Burn-out Cylinders of Solid Abutment.
- Center Pin have 4 different diameters according to the profile diameter of Solid Abutments.

Diameter	Type	Ref.C
Ø10.0	Reamer Drill	TANRD
Ø4.0	Center Pin	RDJ40
Ø4.5		RDJ45
Ø5.5		RDJ55
Ø6.5		RDJ65



Slot Driver (Slotted type)

- Useful for the placement or removal of AnyOne Healing Abutment which has slot on the top.

Length(mm)	Type	Ref.C
10	Short	SDS06
15	Middle	SDM06
20	Long	SDL06



Multi-unit Driver (2.0 Hex) (For Multi-unit Abutment)

- For the seating & tightening of Multi-unit Abutment (Straight type)

Length(mm)	Type	Ref.C
10	Short	TCMMUDS20
15	Long	TCMMUDL20

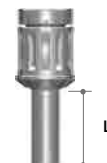

Tap Drill

- Can use both Handpiece(Dental implant engine) & Ratchet Wrench

Diameter	Marking	Ref.C
Ø3.9	7/ 8.5/ 10/ 11.5/ 13/ 15	TD35
Ø4.3		TD40
Ø4.8		TD45
Ø5.3		TD50
Ø6.3		TD60
Ø7.3		TD70

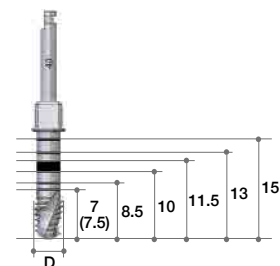

Torque Wrench & Adapter

- Torque Wrench has various options to control the force from 15Ncm ~ 45Ncm and can be used for engaging with Abutment Screw

Type	Ref.C
Torque Wrench	MTW300AT
*Right Angle Adapter (Handpiece)	TTAI100
Torque Wrench Adapter (Ratchet)	TTAR100

(*) Separate sales item.

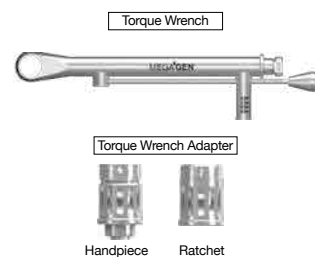

Mount Removal Driver

Length(mm)	Ref.C
19	MVD100



Digital Material

I. ZrGEN[®]

ZrGEN[®] is the brand name of MegaGen Titanium Base. ZrGEN provides an aesthetic outcome and simplified dental implant prosthesis. A ZrGEN[®] crown and monolithic crown connected to a ZrGEN[®] Abutment provide strong and precise connection with the implant fixture.

Variety of ZrGEN[®]



ZrGEN[®] Sub Structure



ZrGEN[®]

The strength of ZrGEN[®] frees you from the chipping of conventional PFM prosthesis. Monolithic zirconia crowns have no metal substructure, ensuring more aesthetic results. ZrGEN[®] crown and bridge are a superior substitutes for all conventional dental materials.



Clinical Application



II. TiGEN[®]

TiGEN[®] is the brand name of MegaGen Titanium customized abutment. It promises outstanding durability and simplified dental implant prosthesis. Ready-made connection part provides a strong and precise connection with the implant fixture.



➔ ZrGEN[®] Prosthesis



ZrGEN[®] Abutment

ZrGEN[®] Abutment provides a strong and precise connection with the implant fixture. With Zirconia[®] coping, crown margins can be placed supragingivally since zirconia material matches with the color of natural teeth. Residual cement problems are no longer an issue.

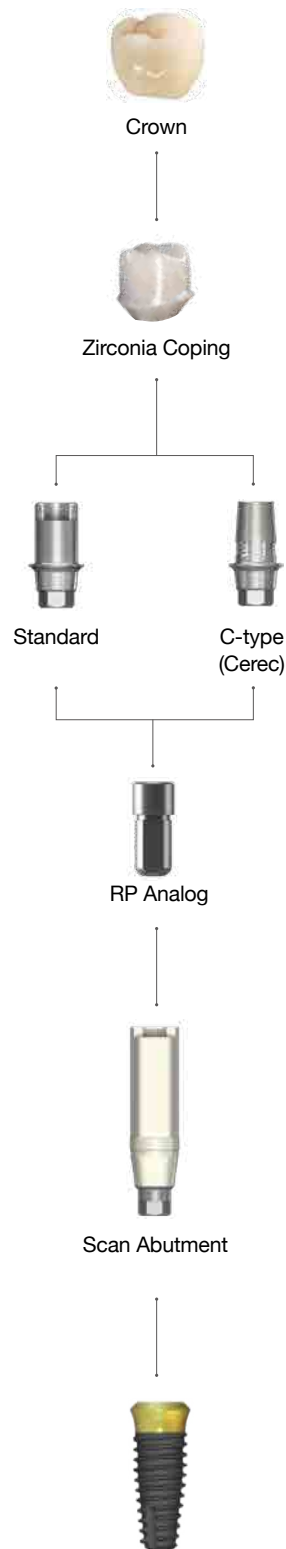

Scan Abutment Option

Scan Abutment

- Abutment Screw included.
- . AnyRidge (AANMSF)
- . AnyRidge Octa 1 (AROAS16B/ AROAS16)
- . AnyOne Internal (AS20)
- . AnyOne Exeternal (SCS160/ RCS200)
- . AnyOne OneStage (EXIMS100)
- . MiNi (MIAS14)
- . ST (OSGSAS3110/ OSGSAS3210)
- . Octa Level (IRCS200)
- . Multi-unit Abutment (MUAS)

- For Chairside/ Labside
- Included spare Abutment Screw
- Supporting Dental CAD
 - 3 Shape
 - Exocad
 - Dental Wings

System	Profile Diameter	Length (mm)	Type	Ref.C
AnyRidge	Ø4.0	9	-	AANISR4009T
		13	-	AANISR4013T
AnyRidge Octa 1	Ø4.0	13	NC	AROSANT
			RC	AROSART
AnyOne Internal	Ø4.0	9	-	AAOISR4009T
		13	-	AAOISR4013T
AnyOne External	Ø4.0	9	Small	AEXESS4009T
			13	AEXESS4013T
		13	Regular	AEXESR4009T
			AEXESR4013T	
AnyOne OneStage	Ø4.0	13	Cuff 1.8	AEXISR4010T
MiNi	3.5	9	-	MISS3509T
		13	-	MISS3513T
ST	Ø4.0	9	Small	OSGSSC3110T
			13	OSGSSC3111T
		13	Regular	OSGSSC3210T
			OSGSSC3211T	
Octa Level	Ø4.0	11	-	AOCESC4011T
MUA Level (N-Type)	Ø4.0	13	-	AMUASR4013T



Scan Abutment (C-type)

- Abutment Screw included.
- . AnyRidge (AANMSF)
- . AnyOne (AS20)
- . AnyRidge Octa 1 (AROAS16B/ AROAS16)

- Scan Post for Sirona Cerec users → CEREC
- In in Lab CAD Software, compatible with
- Xive Library

System	Profile Diameter	Cuff Height	Post Size	Ref.C		
AnyRidge	Ø3.9	0.5	Small	ARICSS3405T		
		1		ARICSS3410T		
		2		ARICSS3420T		
	Ø4.3	0.5	Small	ARICSS3805T		
		1		ARICSS3810T		
		2		ARICSS3820T		
AnyRidge Octa 1	Ø3.9	0.5	Small	ARICSL4505T		
		1		ARICSL4510T		
		2		ARICSL4520T		
	Ø4.3	0.5	Small	AROCSS3405NT		
		1		AROCSS3410NT		
		2		AROCSS3420NT		
AnyOne	Ø3.9	0.5	Small	AROCSS3805NT		
		1		AROCSS3810NT		
		2		AROCSS3820NT		
	Ø4.3	0.5	Small	AROCSS3405RT		
		1		AROCSS3410RT		
		2		AROCSS3420RT		
Ø5.5	0.5	Large	AROCSS3805RT			
	1		AROCSS3810RT			
	2		AROCSS3820RT			
AnyOne	Ø3.9	0.5	Small	AROCSS3405RT		
				1	AROCSS3410RT	
				2	AROCSS3420RT	
		Ø4.3		0.5	AROCSS3805RT	
					1	AROCSS3810RT
					2	AROCSS3820RT
	Ø5.5	0.5	Large	AROCSS3405T		
				1	AROCSS3410T	
				2	AROCSS3420T	
		Ø4.3		0.5	AOICSS3805T	
					1	AOICSS3810T
					2	AOICSS3820T
Ø5.5	0.5	AOICSL4505T				
		1	AOICSL4510T			
		2	AOICSL4520T			

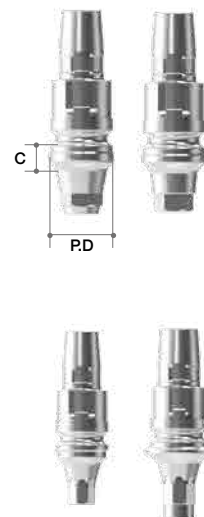

Scan Healing Abutment & Scan Post

- Abutment Screw included.
- AnyRidge (ARIHS1804/ARIHS1805/ARIHS1807)
- AnyOne (AOIHS2004/AOIHS2005/AOIHS2007)
- AnyRidge Octa 1 (AROHS1604/AROHS1605/ AROHS1607)

- Can get scan data without removing Scan Healing Abutment from Scan Post
- Different colors depend on the cuff size
- Scan healing abutment should be exposed 2.0mm on the surgical site for accurate scanning

- Scan Healing Abutment should be exposed 2.0mm from the surgical site for accurate scanning. Scanning would be much easier if you connect Scan Post when scanning seems difficult due to less exposure of Scan Healing Abutment or other conditions.
- Select Scan Post based on the diameter of Scan Healing Abutment
- Scan Post is a disposable product and sold separately in batch of 10EA. for each package

System	Profile Diameter	Scan Post	Height (mm)	Ref.C
AnyRidge	Ø4.0	SP4007.MTN	4	ARISH4004T
			5	ARISH4005T
			7	ARISH4007T
	Ø5.0	SP5007.MTN	4	ARISH5004T
			5	ARISH5005T
			7	ARISH5007T
	Ø6.0	SP6007.MTN	4	ARISH6004T
			5	ARISH6005T
			7	ARISH6007T
	Ø7.0	SP7007.MTN	4	ARISH7004T
			5	ARISH7005T
			7	ARISH7007T
	Ø5.0 (Extra type)	SP5007.MTN	4	ARNSH5004T
			5	ARNSH5005T
			7	ARNSH5007T
	Ø6.0 (Extra type)	SP6007.MTN	4	ARNSH6004T
			5	ARNSH6005T
			7	ARNSH6007T
AnyRidge Octa 1	Ø4.0	SP4007.MTN	4	AROISHN4004T
			5	AROISHN4005T
			7	AROISHN4007T
	Ø5.0	SP5007.MTN	4	AROISHN5004T
			5	AROISHN5005T
			7	AROISHN5007T
	Ø4.0	SP4007.MTN	4	AROISHR4004T
			5	AROISHR4005T
			7	AROISHR4007T
	Ø5.0	SP5007.MTN	4	AROISHR5004T
			5	AROISHR5005T
			7	AROISHR5007T
Ø6.0	SP6007.MTN	4	AROISHR6004T	
		5	AROISHR6005T	
		7	AROISHR6007T	
Ø7.0	SP7007.MTN	4	AROISHR7004T	
		5	AROISHR7005T	
		7	AROISHR7007T	
AnyOne	Ø4.0	SP4007.MTN	4	AOISH4004T
			5	AOISH4005T
			7	AOISH4007T
	Ø4.5	SP5007.MTN	4	AOISH4504T
			5	AOISH4505T
			7	AOISH4507T
	Ø5.5	SP6007.MTN	4	AOISH5504T
			5	AOISH5505T
			7	AOISH5507T
	Ø6.5	SP7007.MTN	4	AOISH6504T
			5	AOISH6505T
			7	AOISH6507T

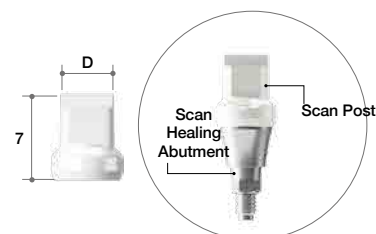

* If Scan Healing Abutment is exposed more than 2.5mm, it may destabilize a fixture and results in fixture failure.

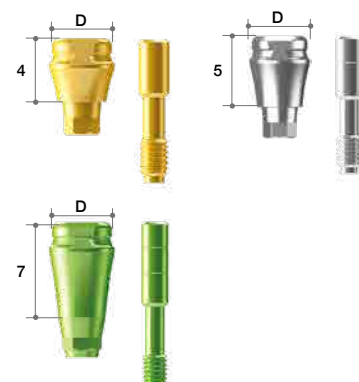

Scan Post Carrier

System	Length	Ref.C
Common	19	SPC16



➔ RP Analog Option

RP Analog

- For Chairside/ Labside
- Included spare Abutment Screw
- Supporting Dental CAD
 - 3 Shape
 - Exocad

System	Profile Diameter	Length (mm)	Type	Ref.C
AnyRidge	Ø4.0	9	-	CANIAR4009
AnyRidge Octa 1	Ø3.3	10	NC	AROLAN
	Ø4.1		RC	AROLAR
AnyOne Internal	Ø4.0	9	Only Ø3.5	CAOIAS3509
			-	CAQIAR4009
AnyOne External	Ø3.5	9	Small	CEXEAS3509
	Ø4.1		Regular	CEXEAR4109
	Ø5.0		Wide	CEXEA5009
AnyOne OneStage	Ø4.8	9	Cuff 1.8	OSRA18
MINi	Ø3.0	9	-	CMIIAN3009
ST	Ø3.7	9	Small	OSRA3709
	Ø4.3		Regular	OSRA4309
Octa Level	Ø3.8	9	Small	OCTARA4
	Ø4.8		Regular	OCTARA5
	Ø5.8		Wide	OCTARA6
MUA Level (N-Type)	Ø4.8	9	-	MUALA

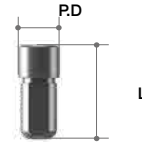

NEW!!

➔ ZrGEN Abutment Option

ZrGEN Abutment

- Abutment Screw included.
 - . AnyRidge (AANMSF)
 - . AnyOne Internal (AS20)
 - . AnyOne Exeternal(SCS160/ RCS200)
 - . AnyOne Stage (
 - . MiNi (MIAZ1410)
 - . ST(OSGSAS3110/OSGSAS3210)
 - . Octa Level(IRCS200)
 - . AnyRidge Octa 1(AROAS16B/ AROAS16)
- Titanium Base
- 1Set(=Abutment 10ea)
 - included spare Abutment Screw
 - MiNi ZrGEN has special ZrGEN Screw
- Supporting DentalCAD
 - 3 Shape
 - Exocad
 - Dental Wing
- Different groove number depend on the post size
 - P=4.5 ▶ groove number : 2ea
 - P=5 ▶ groove number : 3ea
 - P=6 ▶ groove number : 4ea
 - P=8 ▶ groove number : 6ea

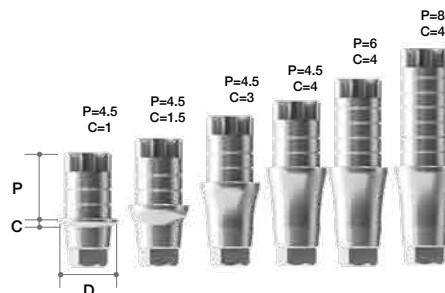

Standard

System	Diameter	Cuff Height	Post Height	Type	Ref.C
AnyRidge	Ø4.0	0.6	4.5	Hex	AANIPR4015.MTN
			6		AANIPR4016.MTN
			8		AANIPR4018.MTN
		1.5	4.5		AANIPR4025.MTN
			6		AANIPR4026.MTN
			8		AANIPR4028.MTN
		3.0	4.5		AANIPR4035.MTN
			6		AANIPR4036.MTN
			8		AANIPR4038.MTN
		4.0	4.5		AANIPR4045.MTN
			6		AANIPR4046.MTN
			8		AANIPR4048.MTN
	Ø4.5	0.6	4.5	Non-Hex	AANIPR4015N.MTN
			6		AANIPR4016N.MTN
			8		AANIPR4018N.MTN
		1.5	4.5		AANIPR4025N.MTN
			6		AANIPR4026N.MTN
			8		AANIPR4028N.MTN
		3.0	4.5		AANIPR4035N.MTN
			6		AANIPR4036N.MTN
			8		AANIPR4038N.MTN
		4.0	4.5		AANIPR4045N.MTN
			6		AANIPR4046N.MTN
			8		AANIPR4048N.MTN
Ø4.5	0.6	4.5	Hex	AANIPR4515.MTN	
		6		AANIPR4516.MTN	
		8		AANIPR4518.MTN	
	1.5	4.5		AANIPR4525.MTN	
		6		AANIPR4526.MTN	
		8		AANIPR4528.MTN	
	3.0	4.5		AANIPR4535.MTN	
		6		AANIPR4536.MTN	
		8		AANIPR4538.MTN	
	4.0	4.5		AANIPR4545.MTN	
		6		AANIPR4546.MTN	
		8		AANIPR4548.MTN	
Ø4.5	0.6	4.5	Non-Hex	AANIPR4515N.MTN	
		6		AANIPR4516N.MTN	
		8		AANIPR4518N.MTN	
	1.5	4.5		AANIPR4525N.MTN	
		6		AANIPR4526N.MTN	
		8		AANIPR4528N.MTN	
	3.0	4.5		AANIPR4535N.MTN	
		6		AANIPR4536N.MTN	
		8		AANIPR4538N.MTN	
	4.0	4.5		AANIPR4545N.MTN	
		6		AANIPR4546N.MTN	
		8		AANIPR4548N.MTN	

System	Diameter	Cuff Height	Post Height	Type	Ref.C			
AnyRidge Octa 1	Ø4.0	NC	4.5	-	AROZGN4015.MTN			
					1.5	AROZGN4025.MTN		
					3.0	AROZGN4035.MTN		
			6.0		4.0	AROZGN4045.MTN		
					0.6	AROZGN4016.MTN		
					1.5	AROZGN4026.MTN		
		8.0	3.0		AROZGN4036.MTN			
			4.0		AROZGN4046.MTN			
			0.6		AROZGN4018.MTN			
		RC	Ø4.5		4.5	-	1.5	AROZGN4028.MTN
							3.0	AROZGN4038.MTN
							4.0	AROZGN4048.MTN
					6.0		0.6	AROZGR4515.MTN
							1.5	AROZGR4525.MTN
							3.0	AROZGR4535.MTN
			8.0		4.0		AROZGR4545.MTN	
					0.6		AROZGR4516.MTN	
					1.5		AROZGR4526.MTN	
MUA Level	Ø5.5		N-Type (Nobel)	-	4.0		AROZGR4548.MTN	
					5		0.8	AMUAPR5515N.MTN
							6	AMUAPR5516N.MTN
		8				AMUAPR5518N.MTN		
		1.7			5	AMUAPR5525N.MTN		
					6	AMUAPR5526N.MTN		
			8		AMUAPR5528N.MTN			
		3.0	5		AMUAPR5535N.MTN			
			6		AMUAPR5536N.MTN			
			8		AMUAPR5538N.MTN			
		4.0	5		AMUAPR5545N.MTN			
			6		AMUAPR5546N.MTN			
8	AMUAPR5548N.MTN							

Standard

System	Diameter	Cuff Height	Post Height	Type	Ref.C
AnyOne Internal	Ø4.0	0.6	4.5	Hex	AAOIPR4015.MTN
			6		AAOIPR4016.MTN
			8		AAOIPR4018.MTN
		1.5	4.5		AAOIPR4025.MTN
			6		AAOIPR4026.MTN
			8		AAOIPR4028.MTN
		3.0	4.5		AAOIPR4035.MTN
			6		AAOIPR4036.MTN
			8		AAOIPR4038.MTN
		4.0	4.5		AAOIPR4045.MTN
			6		AAOIPR4046.MTN
			8		AAOIPR4048.MTN
		Non-Hex	0.6	4.5	AAOIPR4015N.MTN
				6	AAOIPR4016N.MTN
				8	AAOIPR4018N.MTN
			1.5	4.5	AAOIPR4025N.MTN
				6	AAOIPR4026N.MTN
				8	AAOIPR4028N.MTN
			3.0	4.5	AAOIPR4035N.MTN
				6	AAOIPR4036N.MTN
				8	AAOIPR4038N.MTN
			4.0	4.5	AAOIPR4045N.MTN
				6	AAOIPR4046N.MTN
				8	AAOIPR4048N.MTN
	Ø4.5	Hex	0.6	4.5	AAOIPR4515.MTN
				6	AAOIPR4516.MTN
				8	AAOIPR4518.MTN
			1.5	4.5	AAOIPR4525.MTN
				6	AAOIPR4526.MTN
				8	AAOIPR4528.MTN
			3.0	4.5	AAOIPR4535.MTN
				6	AAOIPR4536.MTN
				8	AAOIPR4538.MTN
			4.0	4.5	AAOIPR4545.MTN
				6	AAOIPR4546.MTN
				8	AAOIPR4548.MTN
		Non-Hex	0.6	4.5	AAOIPR4515N.MTN
				6	AAOIPR4516N.MTN
				8	AAOIPR4518N.MTN
			1.5	4.5	AAOIPR4525N.MTN
				6	AAOIPR4526N.MTN
				8	AAOIPR4528N.MTN
			3.0	4.5	AAOIPR4535N.MTN
				6	AAOIPR4536N.MTN
				8	AAOIPR4538N.MTN
			4.0	4.5	AAOIPR4545N.MTN
				6	AAOIPR4546N.MTN
				8	AAOIPR4548N.MTN

System	Diameter	Cuff Height	Post Height	Type	Ref.C
AnyOne External	Small	Ø4.2	0.6	4.5	AEXEPS4015.MTN
				6	AEXEPS4016.MTN
				8	AEXEPS4018.MTN
			1.5	4.5	AEXEPS4025.MTN
				6	AEXEPS4026.MTN
				8	AEXEPS4028.MTN
		3.0	4.5	AEXEPS4035.MTN	
			6	AEXEPS4036.MTN	
			8	AEXEPS4038.MTN	
		4.0	4.5	AEXEPS4045.MTN	
			6	AEXEPS4046.MTN	
			8	AEXEPS4048.MTN	
		Ø4.5	0.6	4.5	AEXEPS4515.MTN
				6	AEXEPS4516.MTN
				8	AEXEPS4518.MTN
			1.5	4.5	AEXEPS4525.MTN
				6	AEXEPS4526.MTN
				8	AEXEPS4528.MTN
			3.0	4.5	AEXEPS4535.MTN
				6	AEXEPS4536.MTN
				8	AEXEPS4538.MTN
			4.0	4.5	AEXEPS4545.MTN
				6	AEXEPS4546.MTN
				8	AEXEPS4548.MTN
	Regular	Ø4.5	0.6	4.5	AEXEPR4515.MTN
				6	AEXEPR4516.MTN
				8	AEXEPR4518.MTN
			1.5	4.5	AEXEPR4525.MTN
				6	AEXEPR4526.MTN
				8	AEXEPR4528.MTN
		3.0	4.5	AEXEPR4535.MTN	
			6	AEXEPR4536.MTN	
			8	AEXEPR4538.MTN	
		4.0	4.5	AEXEPR4545.MTN	
			6	AEXEPR4546.MTN	
			8	AEXEPR4548.MTN	
	Wide	Ø5.5	0.6	4.5	AEXEPW5515.MTN
				6	AEXEPW5516.MTN
				8	AEXEPW5518.MTN
			1.5	4.5	AEXEPW5525.MTN
				6	AEXEPW5526.MTN
				8	AEXEPW5528.MTN
		3.0	4.5	AEXEPW5535.MTN	
			6	AEXEPW5536.MTN	
			8	AEXEPW5538.MTN	
		4.0	4.5	AEXEPW5545.MTN	
			6	AEXEPW5546.MTN	
			8	AEXEPW5548.MTN	
AnyOne OneStage	Cuff 1.8	Ø4.8	0.6	4.5	AEXIPR5015.MTN
				6	AEXIPR5016.MTN
				8	AEXIPR5018.MTN
			1.5	4.5	AEXIPR5025.MTN
				6	AEXIPR5026.MTN
				8	AEXIPR5028.MTN
		3.0	4.5	AEXIPR5035.MTN	
			6	AEXIPR5036.MTN	
			8	AEXIPR5038.MTN	
		4.0	4.5	AEXIPR5045.MTN	
			6	AEXIPR5046.MTN	
			8	AEXIPR5048.MTN	
	Octa	Ø4.8	0.6	4.5	AEXIPR5015.MTN
				6	AEXIPR5016.MTN
				8	AEXIPR5018.MTN
			1.5	4.5	AEXIPR5025.MTN
				6	AEXIPR5026.MTN
				8	AEXIPR5028.MTN
		3.0	4.5	AEXIPR5035.MTN	
			6	AEXIPR5036.MTN	
			8	AEXIPR5038.MTN	
		4.0	4.5	AEXIPR5045.MTN	
			6	AEXIPR5046.MTN	
			8	AEXIPR5048.MTN	

Standard

System	Diameter	Cuff Height	Post Height	Type	Ref.C			
MINi	Ø3.0	0.6	2.5	Hex	MIPN3013.MTN			
			2.5	Non-Hex	MIPN3013N.MTN			
Small	Ø4.0	0.6	4.5	Hex	OSGSPA3111.MTN			
			6		OSGSPA3112.MTN			
		1.5	8		OSGSPA3113.MTN			
			4.5		OSGSPA3121.MTN			
		3.0	6		OSGSPA3122.MTN			
			8		OSGSPA3123.MTN			
		4.0	4.5		OSGSPA3131.MTN			
			6		OSGSPA3132.MTN			
		4.0	8		OSGSPA3133.MTN			
			4.5		OSGSPA3141.MTN			
		0.6	6		OSGSPA3142.MTN			
			8		OSGSPA3143.MTN			
		1.5	4.5		OSGSPA3111N.MTN			
			6		OSGSPA3112N.MTN			
		3.0	8		OSGSPA3113N.MTN			
			4.5		OSGSPA3121N.MTN			
		4.0	6		OSGSPA3122N.MTN			
			8		OSGSPA3123N.MTN			
		4.0	4.5		OSGSPA3131N.MTN			
			6		OSGSPA3132N.MTN			
		4.0	8		OSGSPA3133N.MTN			
			4.5		OSGSPA3141N.MTN			
		Regular	Ø4.0		0.6	4.5	Hex	OSGSPA3142N.MTN
						6		OSGSPA3143N.MTN
1.5	8			OSGSPA3211.MTN				
	4.5			OSGSPA3212.MTN				
3.0	6			OSGSPA4018.MTN				
	8			OSGSPA4025.MTN				
4.0	4.5			OSGSPA4026.MTN				
	6			OSGSPA4028.MTN				
4.0	8			OSGSPA4035.MTN				
	4.5			OSGSPA4036.MTN				
0.6	6			OSGSPA4038.MTN				
	8			OSGSPA4038.MTN				
1.5	4.5			OSGSPA4045.MTN				
	6			OSGSPA4046.MTN				
3.0	8			OSGSPA4048.MTN				
	4.5			OSGSPA3211N.MTN				
4.0	6			OSGSPA3212N.MTN				
	8			OSGSPA4018N.MTN				
4.0	4.5			OSGSPA4025N.MTN				
	6			OSGSPA4026N.MTN				
4.0	8			OSGSPA4028N.MTN				
	4.5			OSGSPA4035N.MTN				
4.0	6			OSGSPA4036N.MTN				
	8			OSGSPA4038N.MTN				
Wide	Ø4.5	0.6	4.5	Hex	OSGSPA4038N.MTN			
			6		OSGSPA4045N.MTN			
		1.5	8		OSGSPA4046N.MTN			
			4.5		OSGSPA4048N.MTN			
		3.0	6		OSGSPA4515.MTN			
			8		OSGSPA4516.MTN			
		4.0	4.5		OSGSPA4518.MTN			
			6		OSGSPA3221.MTN			
		4.0	8		OSGSPA3222.MTN			
			4.5		OSGSPA4528.MTN			
		4.0	6		OSGSPA4535.MTN			
			8		OSGSPA4536.MTN			
		4.0	4.5		OSGSPA4538.MTN			
			6		OSGSPA4538.MTN			
		4.0	8		OSGSPA4545.MTN			
			4.5		OSGSPA4546.MTN			
		4.0	6		OSGSPA4548.MTN			
			8		OSGSPA4515N.MTN			
		4.0	4.5		OSGSPA4516N.MTN			
			6		OSGSPA4518N.MTN			
		4.0	8		OSGSPA3221N.MTN			
			4.5		OSGSPA3222N.MTN			
		4.0	6		OSGSPA4528N.MTN			
			8		OSGSPA4535N.MTN			
4.0	4.5	OSGSPA4536N.MTN						
	6	OSGSPA4538N.MTN						
4.0	8	OSGSPA4545N.MTN						
	4.5	OSGSPA4546N.MTN						
4.0	6	OSGSPA4548N.MTN						
	8	OSGSPA4548N.MTN						

System	Diameter	Cuff Height	Post Height	Type	Ref.C
Small	Ø5.0	0.8	5	Octa	AOCEPS5015.MTN
			6		AOCEPS5016.MTN
		1.7	8		AOCEPS5018.MTN
			5		AOCEPS5025.MTN
		3.0	6		AOCEPS5026.MTN
			8		AOCEPS5028.MTN
		4.0	5		AOCEPS5035.MTN
			6		AOCEPS5036.MTN
		4.0	8		AOCEPS5038.MTN
			5		AOCEPS5045.MTN
		4.0	6		AOCEPS5046.MTN
			8		AOCEPS5048.MTN
		0.8	5		ANOEPS5015.MTN
			6		ANOEPS5016.MTN
		1.7	8		ANOEPS5018.MTN
			5		ANOEPS5025.MTN
		3.0	6		ANOEPS5026.MTN
			8		ANOEPS5028.MTN
		4.0	5		ANOEPS5035.MTN
			6		ANOEPS5036.MTN
		4.0	8		ANOEPS5038.MTN
			5		ANOEPS5045.MTN
		4.0	6		ANOEPS5046.MTN
			8		ANOEPS5048.MTN
Octa Level	Ø5.5	0.8	5	Octa	AOCEPR5515.MTN
			6		AOCEPR5516.MTN
		1.7	8		AOCEPR5518.MTN
			5		AOCEPR5525.MTN
		3.0	6		AOCEPR5526.MTN
			8		AOCEPR5528.MTN
		4.0	5		AOCEPR5535.MTN
			6		AOCEPR5536.MTN
		4.0	8		AOCEPR5538.MTN
			5		AOCEPR5545.MTN
		4.0	6		AOCEPR5546.MTN
			8		AOCEPR5548.MTN
		0.8	5		ANOEPR5515.MTN
			6		ANOEPR5516.MTN
		1.7	8		ANOEPR5518.MTN
			5		ANOEPR5525.MTN
		3.0	6		ANOEPR5526.MTN
			8		ANOEPR5528.MTN
		4.0	5		ANOEPR5535.MTN
			6		ANOEPR5536.MTN
		4.0	8		ANOEPR5538.MTN
			5		ANOEPR5545.MTN
		4.0	6		ANOEPR5546.MTN
			8		ANOEPR5548.MTN
Wide	Ø6.5	0.8	5	Octa	AOCEPW6515.MTN
			6		AOCEPW6516.MTN
		1.7	8		AOCEPW6518.MTN
			5		AOCEPW6525.MTN
		3.0	6		AOCEPW6526.MTN
			8		AOCEPW6528.MTN
		4.0	5		AOCEPW6535.MTN
			6		AOCEPW6536.MTN
		4.0	8		AOCEPW6538.MTN
			5		AOCEPW6545.MTN
		4.0	6		AOCEPW6546.MTN
			8		AOCEPW6548.MTN
		0.8	5		ANOEPW6515.MTN
			6		ANOEPW6516.MTN
		1.7	8		ANOEPW6518.MTN
			5		ANOEPW6525.MTN
		3.0	6		ANOEPW6526.MTN
			8		ANOEPW6528.MTN
		4.0	5		ANOEPW6535.MTN
			6		ANOEPW6536.MTN
		4.0	8		ANOEPW6538.MTN
			5		ANOEPW6545.MTN
		4.0	6		ANOEPW6546.MTN
			8		ANOEPW6548.MTN



Extra

System	Fixture Core	Diameter	Cuff Height	Post Height	Type	Ref.C			
AnyRidge	Core 3.3	Ø4.5	0.6	4.5	Hex	ARZXM4515.MTN			
				6		ARZXM4516.MTN			
				8		ARZXM4518.MTN			
			1.5	4.5		ARZXM4525.MTN			
				6		ARZXM4526.MTN			
				8		ARZXM4528.MTN			
			3.0	4.5		ARZXM4535.MTN			
				6		ARZXM4536.MTN			
				8		ARZXM4538.MTN			
			4.0	4.5		ARZXM4545.MTN			
				6		ARZXM4546.MTN			
				8		ARZXM4548.MTN			
			0.6	Non -Hex		4.5	ARZXM4515N.MTN		
						6	ARZXM4516N.MTN		
						8	ARZXM4518N.MTN		
						1.5	4.5	ARZXM4525N.MTN	
							6	ARZXM4526N.MTN	
							8	ARZXM4528N.MTN	
						3.0	4.5	ARZXM4535N.MTN	
							6	ARZXM4536N.MTN	
							8	ARZXM4538N.MTN	
						4.0	4.5	ARZXM4545N.MTN	
							6	ARZXM4546N.MTN	
							8	ARZXM4548N.MTN	
	AnyRidge	Core3.8	Ø5.0	0.6	4.5	Hex	ARZXM503815.MTN		
					6		ARZXM503816.MTN		
					8		ARZXM503818.MTN		
				1.5	4.5		ARZXM503825.MTN		
					6		ARZXM503826.MTN		
					8		ARZXM503828.MTN		
				3.0	4.5		ARZXM503835.MTN		
					6		ARZXM503836.MTN		
					8		ARZXM503838.MTN		
				4.0	4.5		ARZXM503845.MTN		
					6		ARZXM503846.MTN		
					8		ARZXM503848.MTN		
				0.6	Non -Hex		4.5	ARZXM503815N.MTN	
							6	ARZXM503816N.MTN	
							8	ARZXM503818N.MTN	
							1.5	4.5	ARZXM503825N.MTN
								6	ARZXM503826N.MTN
								8	ARZXM503828N.MTN
							3.0	4.5	ARZXM503835N.MTN
								6	ARZXM503836N.MTN
								8	ARZXM503838N.MTN
							4.0	4.5	ARZXM503845N.MTN
								6	ARZXM503846N.MTN
								8	ARZXM503848N.MTN
0.6		Hex	Ø5.5	0.6	4.5	ARZXM553815.MTN			
					6	ARZXM553816.MTN			
					8	ARZXM553818.MTN			
				1.5	4.5	ARZXM553825.MTN			
					6	ARZXM553826.MTN			
					8	ARZXM553828.MTN			
				3.0	4.5	ARZXM553835.MTN			
					6	ARZXM553836.MTN			
					8	ARZXM553838.MTN			
				4.0	4.5	ARZXM553845.MTN			
					6	ARZXM553846.MTN			
					8	ARZXM553848.MTN			
		Non -Hex		4.5	ARZXM553815N.MTN				
				6	ARZXM553816N.MTN				
				8	ARZXM553818N.MTN				
				1.5	4.5	ARZXM553825N.MTN			
					6	ARZXM553826N.MTN			
					8	ARZXM553828N.MTN			
				3.0	4.5	ARZXM553835N.MTN			
					6	ARZXM553836N.MTN			
					8	ARZXM553838N.MTN			
				4.0	4.5	ARZXM553845N.MTN			
					6	ARZXM553846N.MTN			
					8	ARZXM553848N.MTN			

Extra

System	Fixture Core	Diameter	Cuff Height	Post Height	Type	Ref.C	
AnyRidge	Core4.0	Ø5.0	0.6	4.5	Hex	ARZXM5015.MTN	
				6		ARZXM5016.MTN	
				8		ARZXM5018.MTN	
			1.5	4.5		ARZXM5025.MTN	
				6		ARZXM5026.MTN	
				8		ARZXM5028.MTN	
			3.0	4.5		ARZXM5035.MTN	
				6		ARZXM5036.MTN	
				8		ARZXM5038.MTN	
			4.0	4.5		ARZXM5045.MTN	
				6		ARZXM5046.MTN	
				8		ARZXM5048.MTN	
		Ø5.5	0.6	4.5	Non -Hex	ARZXM5015N.MTN	
				6		ARZXM5016N.MTN	
				8		ARZXM5018N.MTN	
			1.5	4.5		ARZXM5025N.MTN	
				6		ARZXM5026N.MTN	
				8		ARZXM5028N.MTN	
			3.0	4.5		ARZXM5035N.MTN	
				6		ARZXM5036N.MTN	
				8		ARZXM5038N.MTN	
			4.0	4.5		ARZXM5045N.MTN	
				6		ARZXM5046N.MTN	
				8		ARZXM5048N.MTN	
		Ø5.5	0.6	4.5	Hex	ARZXM5515.MTN	
				6		ARZXM5516.MTN	
				8		ARZXM5518.MTN	
				1.5		4.5	ARZXM5525.MTN
						6	ARZXM5526.MTN
						8	ARZXM5528.MTN
				3.0		4.5	ARZXM5535.MTN
						6	ARZXM5536.MTN
						8	ARZXM5538.MTN
				4.0		4.5	ARZXM5545.MTN
						6	ARZXM5546.MTN
						8	ARZXM5548.MTN
			0.6	4.5	Non -Hex	ARZXM5515N.MTN	
				6		ARZXM5516N.MTN	
				8		ARZXM5518N.MTN	
				1.5		4.5	ARZXM5525N.MTN
						6	ARZXM5526N.MTN
						8	ARZXM5528N.MTN
				3.0		4.5	ARZXM5535N.MTN
						6	ARZXM5536N.MTN
						8	ARZXM5538N.MTN
				4.0		4.5	ARZXM5545N.MTN
						6	ARZXM5546N.MTN
						8	ARZXM5548N.MTN

System	Fixture Core	Diameter	Cuff Height	Post Height	Type	Ref.C
AnyRidge	Core 4.8	Ø5.5	0.6	4.5	Hex	ARZXL5515.MTN
				6		ARZXL5516.MTN
				8		ARZXL5518.MTN
			1.5	4.5		ARZXL5525.MTN
				6		ARZXL5526.MTN
				8		ARZXL5528.MTN
			3.0	4.5		ARZXL5535.MTN
				6		ARZXL5536.MTN
				8		ARZXL5538.MTN
			4.0	4.5		ARZXL5545.MTN
				6		ARZXL5546.MTN
				8		ARZXL5548.MTN
		Ø6.0	0.6	4.5	Non -Hex	ARZXL6015N.MTN
				6		ARZXL6016N.MTN
				8		ARZXL6018N.MTN
			1.5	4.5		ARZXL6025N.MTN
				6		ARZXL6026N.MTN
				8		ARZXL6028N.MTN
			3.0	4.5		ARZXL6035N.MTN
				6		ARZXL6036N.MTN
				8		ARZXL6038N.MTN
			4.0	4.5		ARZXL6045N.MTN
				6		ARZXL6046N.MTN
				8		ARZXL6048N.MTN
		0.6	4.5	Hex	ARZXL6015.MTN	
			6		ARZXL6016.MTN	
			8		ARZXL6018.MTN	
			1.5		4.5	ARZXL6025.MTN
					6	ARZXL6026.MTN
					8	ARZXL6028.MTN
			3.0		4.5	ARZXL6035.MTN
					6	ARZXL6036.MTN
					8	ARZXL6038.MTN
			4.0		4.5	ARZXL6045.MTN
					6	ARZXL6046.MTN
					8	ARZXL6048.MTN
		0.6	4.5	Non -Hex	ARZXL6015N.MTN	
			6		ARZXL6016N.MTN	
			8		ARZXL6018N.MTN	
			1.5		4.5	ARZXL6025N.MTN
					6	ARZXL6026N.MTN
					8	ARZXL6028N.MTN
			3.0		4.5	ARZXL6035N.MTN
					6	ARZXL6036N.MTN
					8	ARZXL6038N.MTN
			4.0		4.5	ARZXL6045N.MTN
					6	ARZXL6046N.MTN
					8	ARZXL6048N.MTN

- ZrGEN Abutment

- Ti-base for Sirona Cerec users → CEREC
- In in Lab CAD Software, compatible with Xive Library

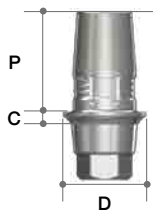
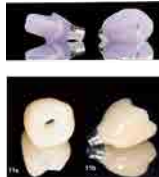

C-Type

System	Diameter	Cuff Height	Post Height	Post Size	Ref.C		
AnyRidge	Ø3.9	0.5	4.7	Small	ARCS3405.MTN		
		1			ARCS3410.MTN		
		2			ARCS3420.MTN		
	Ø4.3	0.5			ARCS3805.MTN		
		1			ARCS3810.MTN		
		2			ARCS3820.MTN		
	Ø5.5	0.5		Large	ARCL4505.MTN		
		1			ARCL4510.MTN		
		2			ARCL4520.MTN		
AnyRidge Octa 1	Ø3.9	0.5	4.5	Small	AROCSN3405.MTN		
		1.0			AROCSN3410.MTN		
		2.0			AROCSN3420.MTN		
		Ø4.3			0.5	AROCSN3805.MTN	
					1.0	AROCSN3810.MTN	
					2.0	AROCSN3820.MTN	
	Ø3.9	0.5		Small	AROCSR3405.MTN		
		1.0			AROCSR3410.MTN		
		2.0			AROCSR3420.MTN		
		Ø4.3			0.5	AROCSR3805.MTN	
					1.0	AROCSR3810.MTN	
					2.0	AROCSR3820.MTN	
	Ø5.5	0.5		Large	AROCLR4505.MTN		
		1.0			AROCLR4510.MTN		
		2.0			AROCLR4520.MTN		
	AnyOne	Ø3.9		0.5	4.7	Small	AOCS3405.MTN
				1			AOCS3410.MTN
				2			AOCS3420.MTN
Ø4.3		0.5	AOCS3805.MTN				
		1	AOCS3810.MTN				
		2	AOCS3820.MTN				
Ø5.5		0.5	Large	AOCL4505.MTN			
		1		AOCL4510.MTN			
		2		AOCL4520.MTN			
ST	Ø3.9	0.5	4.7	Small	STCSS3405.MTN		
		1			STCSS3410.MTN		
		2			STCSS3420.MTN		
		Ø4.3			0.5	STCSS3805.MTN	
					1	STCSS3810.MTN	
					2	STCSS3820.MTN	
	Ø3.9	0.5		Small	STCSR3405.MTN		
		1			STCSR3410.MTN		
		2			STCSR3420.MTN		
		Ø4.3			0.5	STCSR3805.MTN	
					1	STCSR3810.MTN	
					2	STCSR3820.MTN	
	Ø5.5	0.5		Large	STCLR4505.MTN		
		1			STCLR4510.MTN		
		2			STCLR4520.MTN		

Scan Abutmet (C-type)

- Abutment Screw included.
 - . AnyRidge (AANMSF)
 - . AnyOne (AS20)
 - . AnyRidge Octa 1 (AROAS16B/ AROAS16)

- Scan Post for Sirona Cerec users → CEREC
- In in Lab CAD Software, compatible with
- Xive Library

System	Profile Diameter	Cuff Height	Post Size	Ref.C				
AnyRidge	Ø3.9	0.5	Small	ARICSS3405T				
		1		ARICSS3410T				
		2		ARICSS3420T				
	Ø4.3	0.5		ARICSS3805T				
		1		ARICSS3810T				
		2		ARICSS3820T				
	Ø5.5	0.5	Large	ARICSL4505T				
		1		ARICSL4510T				
		2		ARICSL4520T				
AnyRidge Octa 1	Ø3.9	0.5	Small	AROCSS3405NT				
				1	AROCSS3410NT			
				2	AROCSS3420NT			
		Ø4.3		0.5	AROCSS3805NT			
				1	AROCSS3810NT			
				2	AROCSS3820NT			
	Ø3.9	0.5	Small	AROCSS3405RT				
				1	AROCSS3410RT			
				2	AROCSS3420RT			
		Ø4.3		0.5	AROCSS3805RT			
				1	AROCSS3810RT			
				2	AROCSS3820RT			
	Ø5.5	0.5	Large	AROCSL4505RT				
				1	AROCSL4510RT			
				2	AROCSL4520RT			
		AnyOne		Ø3.9	0.5	Small	AOICSS3405T	
							1	AOICSS3410T
							2	AOICSS3420T
Ø4.3	0.5		AOICSS3805T					
	1		AOICSS3810T					
	2		AOICSS3820T					
Ø5.5	0.5		Large	AOICSL4505T				
				1	AOICSL4510T			
				2	AOICSL4520T			

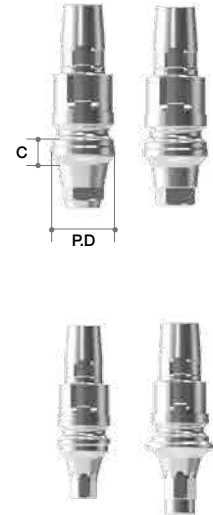

➡ TiGEN Prosthesis



Crown



Milled TiGEN



TiGEN Abutment



RP Analog



Scan Abutment



➔ TiGEN Abutment Option

TiGEN Abutment

- Abutment Screw included.
- . AnyRidge (AANMSF)
- . AnyOne Internal (AS20)
- . AnyOne External(SCS160/ RCS200)
- . AnyOne Stage (
- . MiNi (MAZ1410)
- . ST(OSGSAS3110/OSGSAS3210)
- . Octa Level(IRCS200)
- . AnyRidge Octa 1(AROAS16B/ AROAS16)

- Pre-milled Abutment
- 1Set(=Abutment 10ea)
- included spare Abutment Screw
- Supporting DentalCAD
- 3Shape
- Exocad
- Dental Wings

Standard

System	Color	Diameter	Length	Type	Ref.C		
AnyRidge	Gold	Ø10	20	Hex	ARTR1020.MTN		
				Non-Hex	ARTR1020N.MTN		
		Ø12		Hex	ARTR1220.MTN		
				Non-Hex	ARTR1220N.MTN		
AnyRidge Octa 1	NC Gold	Ø10	20	Hex	AROTGN1020.MTN		
				Non-Hex	AROTGN1220.MTN		
	RC Silver	Ø10		Hex	AROTGR1020.MTN		
				Non-Hex	AROTGR1220.MTN		
AnyOne Internal	Pink	Ø10	20	Hex	AOTR1020.MTN		
				Non-Hex	AOTR1020N.MTN		
		Ø12		Hex	AOTR1220.MTN		
				Non-Hex	AOTR1220N.MTN		
AnyOne External	N/A	Ø12	20	Hex	AETS1220.MTN		
				Hex	AETR1220.MTN		
				Hex	AETW1220.MTN		
MiNi	N/A	Ø10	20	Hex	MITN1020.MTN		
				Non-Hex	MITN1020N.MTN		
ST	Small	Sky	20	Hex	OSTG3112.MTN		
				Non-Hex	OSTG3112N.MTN		
		Ø12		Hex	OSTG3111.MTN		
				Non-Hex	OSTG3111N.MTN		
	Regular	Sky		Ø10	Hex	OSTG3212.MTN	
					Non-Hex	OSTG3212N.MTN	
		Ø12		Hex	OSTG3211.MTN		
				Non-Hex	OSTG3211N.MTN		
Octa Level	Small	N/A	20	Octa	OCTS1020.MTN		
				Non-Octa	NOTS1020.MTN		
		Ø12		Octa	OCTS1220.MTN		
				Non-Octa	NOTS1220.MTN		
		Regular		N/A	Ø10	Octa	OCTR1020.MTN
						Non-Octa	NOTR1020.MTN
	Ø12			Octa	OCTR1220.MTN		
				Non-Octa	NOTR1220.MTN		
	Wide	N/A		Ø10	Octa	OCTW1020.MTN	
					Non-Octa	NOTW1020.MTN	
		Ø12		Octa	OCTW1220.MTN		
				Non-Octa	NOTW1220.MTN		



Extra EZ Connection

System	Color	Fixture Core	Diameter	Length	Type	Ref.C		
AnyRidge	Gold	3.3	Ø10	20	Hex	ARTXN1020.MTN		
					Non-Hex	ARTXN1020N.MTN		
					Ø12	Hex	ARTXN1220.MTN	
						Non-Hex	ARTXN1220N.MTN	
					4.0	Ø10	Hex	ARTXM1020.MTN
							Non-Hex	ARTXM1020N.MTN
		Ø12	Hex		ARTXM1220.MTN			
			Non-Hex		ARTXM1220N.MTN			
		4.8	Ø10		Hex	ARTXL1020.MTN		
					Non-Hex	ARTXL1020N.MTN		
			Ø12		Hex	ARTXL1220.MTN		
					Non-Hex	ARTXL1220N.MTN		



ANYONE[®] Onestage
by MEGAGEN



Head Office & Factory
Gangnam Office

45, Secheon-ro 7-gil, Dasa-eup, Dalseong-gun, Daegu, Korea
MegaGen Tower, 607 Seolleung-ro, Gangnam-gu, Seoul, Korea

T. +82-1544-2285
T. +82-1566-2338